

brother®

- 1 KNOWING YOUR SEWING MACHINE
- 2 SEWING BASICS
- 3 UTILITY STITCHES
- 4 APPENDIX

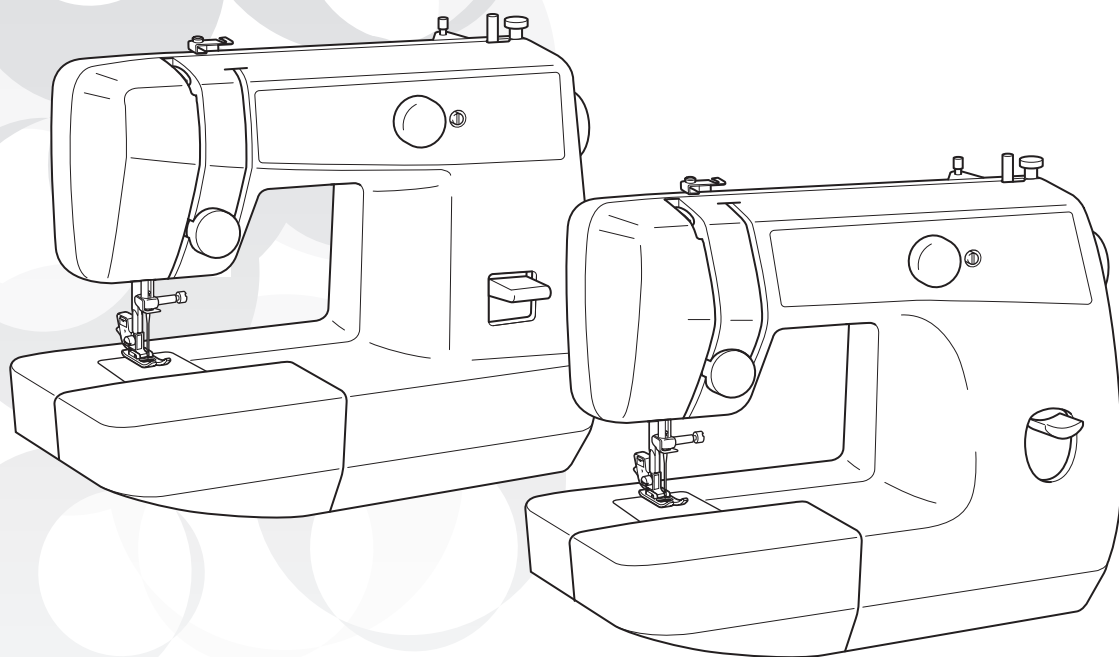

# Basic Sewing and Mending Machine Operation Manual

Please visit us at <http://solutions.brother.com> where you can get product support and answers to frequently asked questions (FAQs).



## **“IMPORTANT SAFETY INSTRUCTIONS”**

When using the sewing machine, basic safety precautions should always be followed, including the following:

“Read all instructions before using.”

**DANGER** – To reduce the risk of electric shock:

1. The sewing machine should never be left unattended when plugged in. Always unplug this sewing machine from the electrical outlet immediately after using and before cleaning.
2. Always unplug before changing the light bulb. Replace bulb with same type rated 15 watts.

**WARNING** – To reduce the risk of burns, fire, electric shock, or injury to persons:

1. Do not allow this machine to be used as a toy. Close attention is necessary when the sewing machine is used by or near children.
2. Use this sewing machine only for its intended use as described in this manual. Use only accessories recommended by the manufacturer as contained in this manual.
3. Never operate this sewing machine if it has a damaged cord or plug, if it is not working properly, if it has been dropped or damaged, or dropped into water. Return the sewing machine to the nearest authorized dealer or service center for examination, repair, electrical or mechanical adjustment.
4. Never operate the sewing machine with any of the air openings blocked. Keep the ventilation openings of the sewing machine and foot controller free from the accumulation of lint, dust and loose cloth.
5. Never drop or insert any object into any openings.
6. Do not use this machine outdoors.
7. Do not operate this machine where aerosol (spray) products are being used or where oxygen is being administered.
8. To disconnect, turn the main switch to the symbol “O” position which represents off, then remove plug from outlet.
9. Do not unplug by pulling on the cord. To unplug, grasp the plug and pull, not the cord.
10. Keep fingers away from all moving parts. Special care is required around the sewing machine needle.
11. Always use the proper needle plate. The wrong plate can cause the needle to break.
12. Do not use a bent needle.
13. Do not pull or push the fabric while stitching. It may deflect the needle causing it to break.
14. Switch the sewing machine to the off, symbol “O” position when making any adjustments in the needle area, such as threading the needle, changing the needle, threading the bobbin, or changing the presser foot.
15. Always unplug the sewing machine from the electrical outlet when removing covers, lubricating, or when making any other user service adjustments mentioned in this instruction manual.
16. This sewing machine is not intended for use by young children or impaired persons without supervision.
17. Young children should be supervised to ensure that they do not play with this sewing machine.

**“SAVE THESE INSTRUCTIONS”**

**“This sewing machine is intended for household use.”**

---

## FOR USERS IN THE UK, EIRE, MALTA AND CYPRUS ONLY

If this machine is fitted with a three-pin non-rewireable BS plug then please read the following.

### IMPORTANT

If the available socket outlet is not suitable for the plug supplied with this equipment, it should be cut off and an appropriate three-pin plug fitted. With alternative plugs an approved fuse must be fitted in the plug.

### NOTE

The plug served from the main lead must be destroyed as a plug with bared flexible cords is hazardous if engaged in a live socket outlet. In the event of replacing the plug fuse, use a fuse approved by ASTA to BS 1362, i.e. carrying the  mark, rating as marked on plug. Always replace the fuse cover, never use plugs with the fuse cover omitted.

### WARNING

**DO NOT CONNECT EITHER WIRE TO THE EARTH TERMINAL WHICH IS MARKED WITH THE LETTER 'E', BY THE EARTH SYMBOL  OR COLOURED GREEN OR GREEN AND YELLOW.**

The wires in this main lead are coloured in accordance with the following code:

Blue	Neutral
Brown	Live

As the colours of the wiring in the main lead of this appliance may not correspond with the coloured markings identifying the terminals in your plug, proceed as follows.

The wire which is coloured blue must be connected to the terminal which is marked with the letter 'N' or coloured black or blue.

The wire which is coloured brown must be connected to the terminal which is marked with the letter 'L' or coloured red or brown.

## CONGRATULATIONS ON CHOOSING OUR MACHINE

To fully enjoy all the features, we suggest that you study the manual before using the machine.

### PLEASE READ BEFORE USING THIS MACHINE

#### For safe operation

1. Be sure to keep your eye on the needle while sewing. Do not touch the handwheel, thread take-up lever, needle, or other moving parts.
2. Remember to turn off the power switch and unplug the cord when:
  - Operation is completed
  - Replacing or removing the needle or any other parts
  - A power failure occurs during use
  - Maintaining the machine
  - Leaving the machine unattended
3. Do not store anything on the foot controller.
4. Plug the machine directly into the wall. Do not use extension cords.

#### For a longer service life

1. When storing this machine, avoid direct sunlight and high humidity locations. Do not use or store the machine near a space heater, iron, halogen lamp, or other hot objects.
2. Use only neutral soaps or detergents to clean the case. Benzene, thinner, and scouring powders can damage the case and machine, and should never be used.
3. Do not drop or hit the machine.
4. Always consult the operation manual when replacing or installing any assemblies, the presser feet, needle, or other parts to assure correct installation.

#### For repair or adjustment

In the event a malfunction occurs or adjustment is required, first follow the troubleshooting table in the back of the operation manual to inspect and adjust the machine yourself. If the problem persists, please consult your local authorized Brother dealer.

**For additional product information and updates, visit our web site at [www.brother.com](http://www.brother.com)**

**The contents of this manual and specifications of this product are subject to change without notice.**

# CONTENTS

<b>1. KNOWING YOUR SEWING MACHINE</b> .....	<b>6</b>
<b>NAMES OF MACHINE PARTS AND THEIR FUNCTIONS</b> .....	<b>6</b>
The main parts .....	6
Needle and presser foot section .....	8
Flat bed attachment .....	8
<b>ACCESSORIES</b> .....	<b>9</b>
<b>USING YOUR SEWING MACHINE</b> .....	<b>10</b>
Power supply precautions .....	10
Power supply .....	10
Foot controller .....	11
Steadying the machine .....	11
<b>THREADING THE MACHINE</b> .....	<b>12</b>
Winding the bobbin .....	12
Lower threading .....	14
Upper threading .....	16
Drawing up the lower thread .....	18
<b>REPLACING THE NEEDLE</b> .....	<b>19</b>
Needle precautions .....	19
Selecting the needle depending on the thread and fabric types .....	19
Checking the needle .....	20
Replacing the needle .....	20
Sewing with a twin needle (Option) .....	22
<b>REPLACING THE PRESSER FOOT</b> .....	<b>23</b>
Replacing the presser foot .....	23
Removing the presser foot holder .....	24
<b>2. SEWING BASICS</b> .....	<b>25</b>
<b>SEWING</b> .....	<b>25</b>
General sewing procedure .....	25
Selecting stitching .....	26
Starting to sew .....	27
Sewing in reverse .....	28
Thread tension .....	28
<b>USEFUL SEWING TIPS</b> .....	<b>30</b>
Trial sewing .....	30
Changing the sewing direction .....	30
Sewing curves .....	30
Sewing thick fabrics .....	30
Sewing thin fabrics .....	31
Sewing stretch fabrics .....	31
Using a free-arm style .....	31
<b>3. UTILITY STITCHES</b> .....	<b>32</b>
<b>USEFUL STITCHES</b> .....	<b>32</b>
Zigzag stitches .....	32
Basic stitching .....	33
Blind hem stitching .....	33
Darning .....	35
<b>BUTTONHOLE SEWING</b> .....	<b>36</b>
Making the buttonhole .....	36
Adjusting buttonhole stitching .....	38
Button sewing .....	38

<b>ZIPPER INSERTION .....</b>	<b>40</b>
<b>APPLIQUÉ, MONOGRAMMING AND EMBROIDERING .....</b>	<b>41</b>
Appliqués .....	41
Monogramming and embroidering .....	41
<b>DECORATIVE STITCHING .....</b>	<b>43</b>
Gathering .....	43
Shell tuck stitching .....	43
Elastic stitching .....	44
<b>4. APPENDIX .....</b>	<b>45</b>
<b>MAINTENANCE .....</b>	<b>45</b>
Oiling .....	45
Changing the bulb .....	45
Cleaning the machine surface .....	46
Cleaning the shuttle race .....	46
Cleaning the feed dogs .....	47
Repacking the machine .....	48
Bobbin case tension adjustment .....	48
<b>TROUBLESHOOTING .....</b>	<b>50</b>
<b>INDEX .....</b>	<b>53</b>

# 1 KNOWING YOUR SEWING MACHINE

## NAMES OF MACHINE PARTS AND THEIR FUNCTIONS

### The main parts

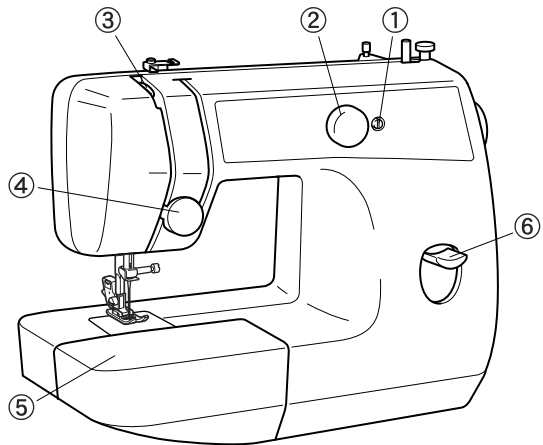
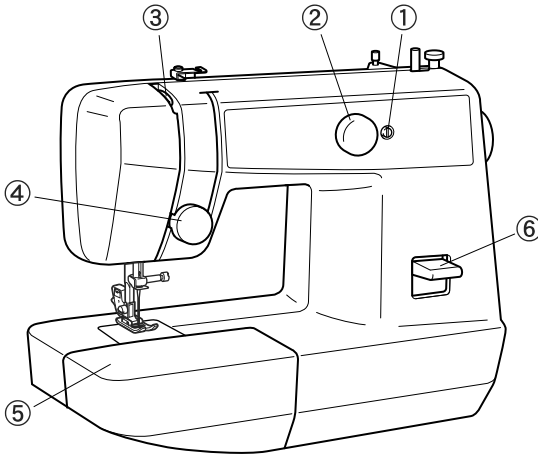

- ① **Buttonhole fine-adjusting screw (page 38)**  
Turn the buttonhole fine-adjusting screw to adjust buttonhole stitching when it is not uniform.
- ② **Pattern selection dial (page 26)**  
Turn the pattern selection dial to select the number of the stitch that you want to use.
- ③ **Thread take-up lever (page 16)**

- ④ **Upper tension control dial (page 28)**  
This controls the tension of the upper thread.
- ⑤ **Flat bed attachment with accessory storage (page 8 and 31)**
- ⑥ **Reverse sewing lever (page 28)**  
Press and hold down the reverse sewing lever to sew in the opposite direction.



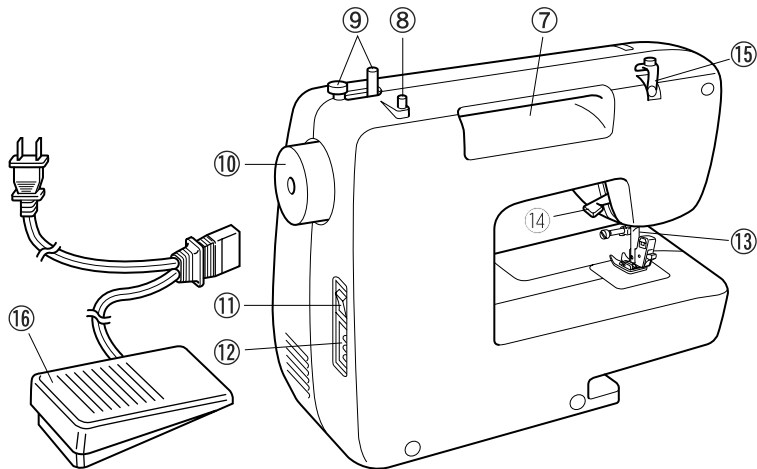

- ⑦ **Built-in handle**
- ⑧ **Spool pin (page 12 and 16)**  
The spool pin holds the spool of thread.
- ⑨ **Bobbin winder (page 12)**  
The bobbin winder winds thread onto the bobbin for use as the lower thread.
- ⑩ **Handwheel**  
Use the handwheel to manually raise and lower the needle.
- ⑪ **Main power/sewing light switch (page 10)**  
Use this switch to turn on and off the main power and sewing light.
- ⑫ **Foot controller jack/jack**  
Insert the foot controller plug into the foot controller jack, which also supplies power to this machine.
- ⑬ **Thread cutter (page 28)**  
Pass the threads through the thread cutter to cut them.
- ⑭ **Presser foot lever (page 16)**  
Use the presser foot lever to raise and lower the presser foot.
- ⑮ **Bobbin winding pre-tension disc/thread guide (page 12 and 16)**  
The thread guide/bobbin winding pre-tension disc is used when winding the thread onto the bobbin and threading the machine.
- ⑯ **Foot controller (page 11)**  
Use the foot controller to control the sewing speed and to start and stop sewing.  
Part code;  
XC7359-021 (110/120V Area),  
XC7438-321 (220/240V Area),  
XC7456-321 (U.K.),  
XE0629-001 (Australia, New Zealand),  
XD0852-021 (Korea),  
XC7438-321 (Russia)

## Needle and presser foot section

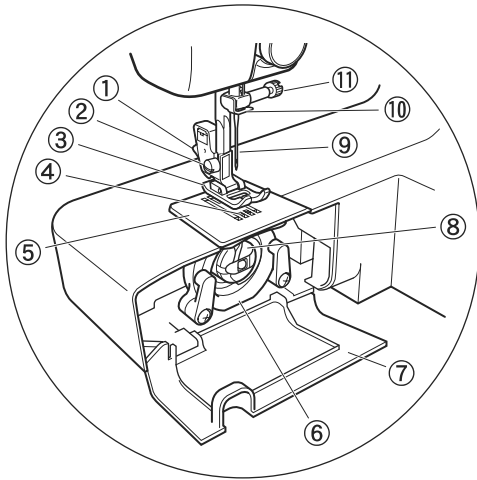

- ① **Presser foot holder assembly**  
The presser foot is installed onto the presser foot holder assembly.
- ② **Presser foot screw**  
Use the presser foot screw to hold the presser foot holder assembly in place.
- ③ **Presser foot (Zigzag)**  
The presser foot applies pressure consistently on the fabric as the sewing takes place. Attach the appropriate presser foot for the selected stitching.
- ④ **Feed dogs**  
The feed dogs feed the fabric in the sewing direction.
- ⑤ **Needle plate**  
The needle plate is marked with guides for sewing straight seams.
- ⑥ **Shuttle hook**
- ⑦ **Shuttle cover**  
Open the shuttle cover to set the bobbin.
- ⑧ **Bobbin case**
- ⑨ **Needle**
- ⑩ **Needle bar thread guide**
- ⑪ **Needle clamp screw**  
Use the needle clamp screw to hold the needle in place.

## Flat bed attachment

The accessories are stored in a compartment inside the flat bed attachment.

- 1 **Lift the bottom of the flat bed attachment toward you, and then pull the flat bed attachment out to remove it.**

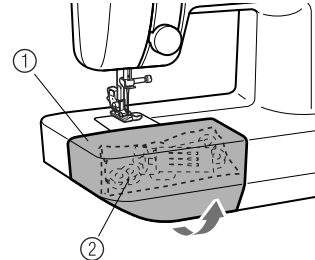

- ① Flat bed attachment
- ② Storage compartment

### Note

- Put the accessories in the bag, and then store the bag inside the compartment. If the accessories are not in a bag, they may fall out, and be lost or damaged.

# ACCESSORIES

The following accessories are stored in the flat bed attachment. We have designed these accessories to help you be able to carry out most sewing tasks.



## Note

(For U.S.A. only)

- Foot controller: Model KD-1902, N  
This foot controller can be used on the following machine models:  
LS-2220/2720/1520/2125/2125i.
- The screw of the presser foot holder is available through your authorized dealer. (Part code: 132730-122)
- A replacement for the factory-installed presser foot is available through your authorized dealer. (Part number: 138135-122)

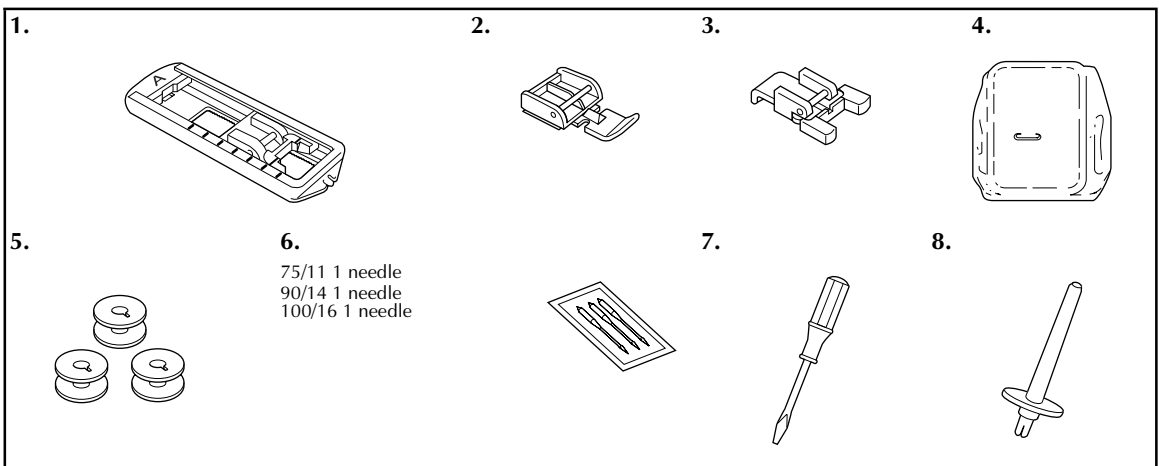

No.	Part Name	Part Code		No.	Part Name	Part Code	
		U.S.A. / Canada	Others			U.S.A. / Canada	Others
1	Buttonhole foot "A"	X59369-321		5	Bobbin (3)	SA156	XA5539-151
2	Zipper foot "I"	X59370-021		6	Needle set	129583-021	
3	Button sewing foot "M"	XE2137-001		7	Screwdriver	X55467-021	
4	Darning plate	XA3442-121		8	Extra spool pin	130920-021	

## USING YOUR SEWING MACHINE

### Power supply precautions

Be sure to observe the following precautions concerning the power supply.

#### **! WARNING**

- Use only regular household electricity for the power source. Using other power sources may result in fire, electric shock, or damage to the machine.
- Turn off the main power and remove the plug in the following circumstances:
  - When you are away from the machine
  - After using the machine
  - When the power fails during use
  - When the machine does not operate correctly due to a bad connection or a disconnection
  - During electrical storms

#### **! CAUTION**

- Do not use extension cords or multi-plug adapters with many other appliances plugged in to them. Fire or electric shock may result.
- Do not touch the plug with wet hands. Electric shock may result.
- When unplugging the machine, always turn off the main power first. Always grasp the plug to remove it from the outlet. Pulling on the cord may damage the cord, or lead to fire or electric shock.
- Do not allow the power cord to be cut, damaged, modified, forcefully bent, pulled, twisted, or bundled. Do not place heavy objects on the cord. Do not subject the cord to heat. These things may damage the cord and cause fire or electric shock. If the cord or plug is damaged, take the machine to your authorized dealer for repairs before continuing use.
- Unplug the power cord if the machine is not to be used for a long period of time. Otherwise a fire may result.

### Power supply

- 1** Insert the foot controller plug, located between the foot controller and the power supply plug on the cord, into the jack on the machine. Then, insert the power supply plug into a wall outlet.

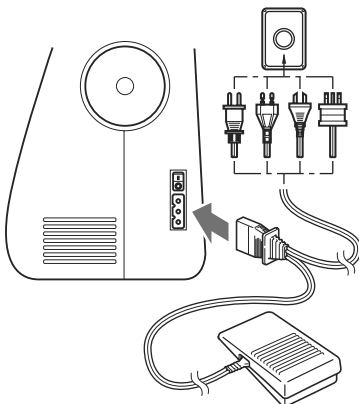

① Foot controller plug

- 2** Set the main power switch to "I".

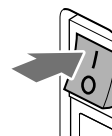

- ▶ The sewing lamp comes on when the machine is turned on.

**3** To turn off the machine, set the main power switch to “O”.

▶ The sewing lamp goes off when the machine is turned off.



### Note

- If a power outage occurs while the sewing machine is being operated, turn off the sewing machine and unplug the power supply cord. When restarting the sewing machine, follow the necessary procedure to correctly operate the machine.

(For U.S.A. only)

- This appliance has a polarized plug (one blade wider than the other). To reduce the risk of electric shock, this plug is intended to fit in a polarized outlet only one way. If the plug does not fit fully in the outlet, reverse the plug. If it still does not fit, contact a qualified electrician to install the proper outlet. Do not modify the plug in any way.

## Foot controller

### ! CAUTION

- When connecting the foot controller, be sure to turn off the sewing machine in order to prevent the machine from accidentally being started.

When you press the foot controller down lightly, the machine will run at a low speed. When you press harder, the machine's speed will increase. When you take your foot off the foot controller, the machine will stop.

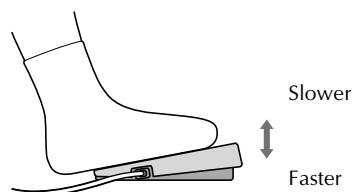

You should make sure that nothing is placed on the foot controller when the machine is not in use.

### ! CAUTION

- Do not allow pieces of cloth and dust to build up on the foot controller. Doing so could cause a fire or an electric shock.
- A new sewing machine or one that has not been in use for a long period of time should be oiled as described on page 45. After oiling, be sure to wipe off any excess oil.

## Steadying the machine

If the sewing machine has been placed on an uneven surface, turn the rubber cushion in the right-front corner of the base plate to adjust its height until the sewing machine is stable.

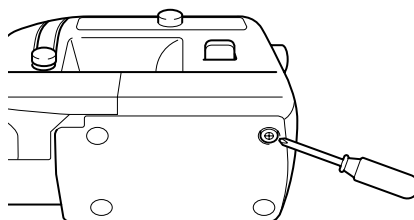

# THREADING THE MACHINE

## Winding the bobbin

This section describes how to wind the thread onto the bobbin.

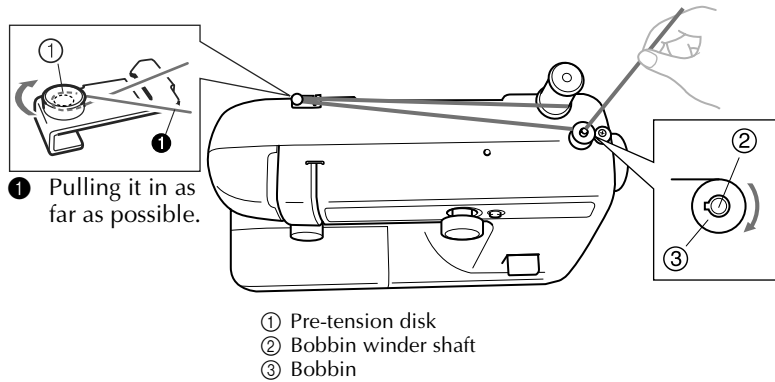

### CAUTION

- Only use bobbins (part code: SA156, SFB: XA5539-151) that have been designed for this sewing machine. Using other bobbins may cause damage to the machine.
- We designed the bobbin that comes with this machine. If you use bobbins from other models, the machine will not work properly. Only use the bobbin that comes with this machine or bobbins of the same type (part code: SA156, SFB: XA5539-151).

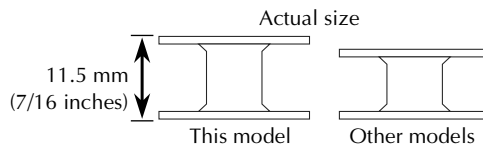

- 1 Pull up the spool pin as far as possible, and then put a spool of thread on this pin.
- 2 Pass the thread around the pre-tension disk.

### CAUTION

- If the spool of thread is not in the right place, the thread may tangle on the spool pin.

- 3 Pass the end of the thread through the hole on the bobbin from the inside of the bobbin.

- 4 Put the bobbin onto the bobbin winder shaft and slide the bobbin winder shaft to the right. Turn the bobbin clockwise, by hand, until the spring on the shaft slides into the groove of the bobbin.

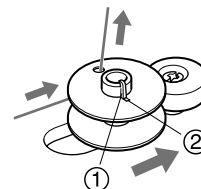

- ① Spring on the shaft
- ② Groove of the bobbin

- 5 Turn on the sewing machine.

- 6** While holding the end of the thread, gently press the foot controller to wind the thread around the bobbin a few times. Then stop the machine.

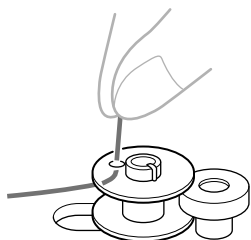

- 7** Trim the excess thread above the bobbin.

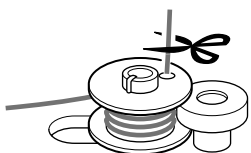

**CAUTION**

- Make sure you follow the instructions carefully. If you do not cut the thread completely, and the bobbin is wound, when the thread runs low it may tangle around the bobbin and cause the needle to break.

- 8** Press the foot controller to start.

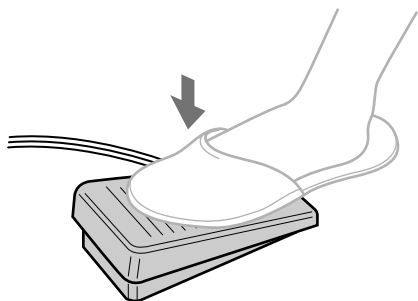

- 9** When the bobbin seems full and begins spinning slowly, take your foot off the foot controller.

- 10** Cut the thread, slide the bobbin winder shaft to the left and remove the bobbin.

**Memo**

- When the sewing machine is started or the handwheel is turned after winding the thread around the bobbin, the machine will make a clicking sound; this is not a malfunction.
- The needle bar does not move when you slide the bobbin winding shaft to the right.

**CAUTION**

- Winding the bobbin improperly may cause the thread tension to loosen, breaking the needle and resulting in injury.

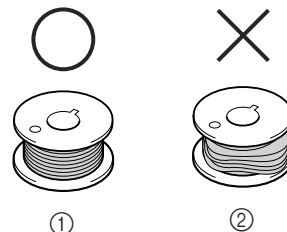

- ① Wound evenly  
② Wound poorly

## Lower threading

Install the bobbin wound with thread.

### CAUTION

- Winding the bobbin improperly may cause the thread tension to loosen, breaking the needle and resulting in injury.

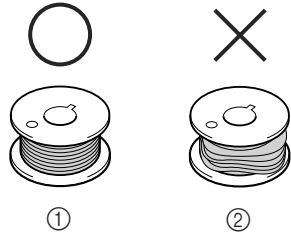

- ① Wound evenly  
② Wound poorly

- The bobbin was designed specifically for this sewing machine. If bobbins from other models are used, the machine will not operate correctly. Use only the enclosed bobbin or bobbins of the same type (part code: SA156, SFB: XA5539-151).

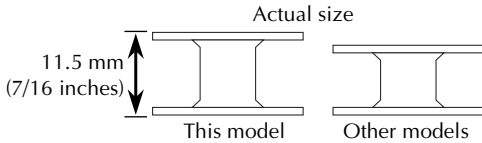

### CAUTION

- Make sure you turn the power off while threading the machine. If you accidentally step on the foot controller and the machine starts to sew, you could be injured.

- 1 Raise the needle to its highest position by turning the handwheel toward you (counterclockwise) and raise the presser foot lever.

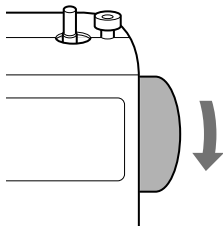

- 2 Open the shuttle cover behind the flat bed attachment at the front of the machine.

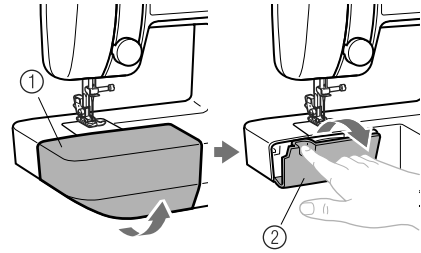

- ① Flat bed attachment  
② Shuttle cover

- 3 Remove the bobbin case by pulling its latch toward you and pulling it out from the shuttle race.

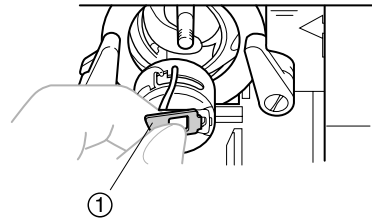

- ① Bobbin case latch

- 4 Unwind about 10 cm (4 inches) of thread from a full bobbin, and then insert the bobbin into the bobbin case.

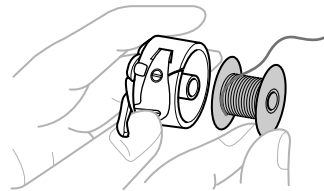

- Only use bobbins that were designed to be used with this machine.

### CAUTION

- Make sure you set the bobbin so the thread unrolls in the right direction. If the thread unrolls in the wrong direction, it may cause the thread tension to be incorrect or break the needle.



**5** Pull the trailing thread through the slot, down and to the left, as shown below, until it enters the delivery eye under the tension spring.

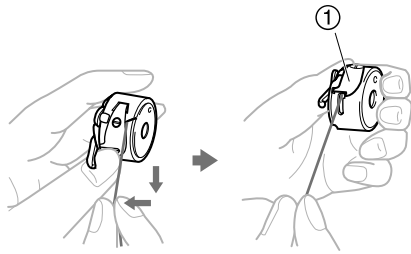

① Tension spring

**6** Hold the bobbin case by the latch, fully insert the bobbin case into the shuttle race, and then release the latch.

- Make sure the bobbin case finger fits into the notch at the top of the shuttle race.

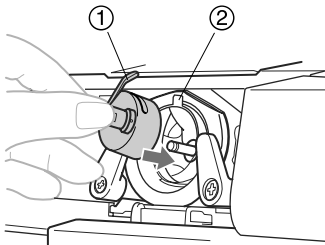

① Bobbin case finger  
② Notch

**7** Close the shuttle cover.

**CAUTION**

- Make sure that the bobbin case is properly placed back into the machine. If it is incorrectly installed, it will fall out from the shuttle when the machine starts to sew.

## Upper threading

Set the upper thread and thread the needle.

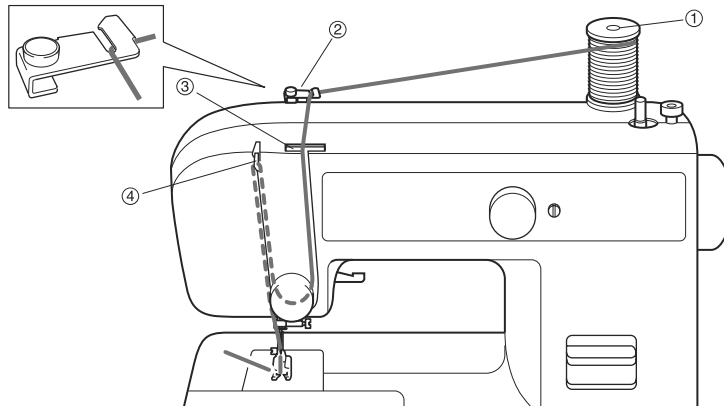

- ① Spool pin
- ② Thread guide (rear)
- ③ Thread guide (front)
- ④ Thread take-up lever

### CAUTION

- Make sure you thread the machine properly. Otherwise, the thread could tangle and break the needle.

- 1** Raise the presser foot using the presser foot lever.

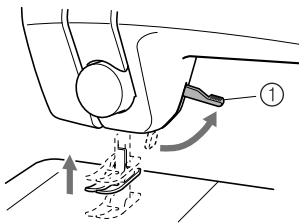

- ① Presser foot lever

- 2** Raise the needle by turning the handwheel toward you (counterclockwise) to raise the thread take-up lever to its highest position.

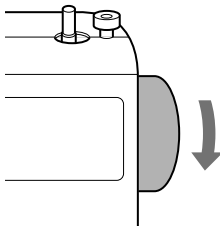

- If the needle is not correctly raised, the sewing machine can not be threaded. Be sure to turn the handwheel before threading the sewing machine.

- 3** Pull up the spool pin as far as possible, and then put a spool of thread on this pin.

### CAUTION

- If the spool of thread is in the wrong place, or is set incorrectly, the thread may tangle on the spool pin and cause the needle to break.

- 4** Feed the upper thread through both thread guides: the rear one first, then the front one.

- 5** Pull the thread down and around the upper tension control dial from the right to the left so the thread picks up the thread check spring.

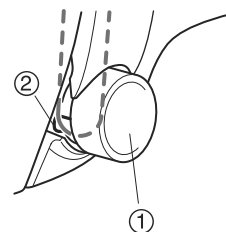

- ① Upper tension control dial
- ② Thread check spring

- 6** While holding the thread as shown below, pull it between the tension discs.

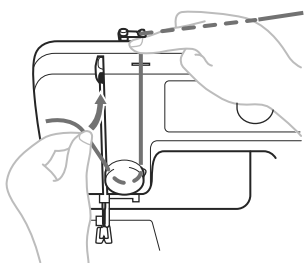

- 7** Guide the thread through the thread take-up lever from right to left.

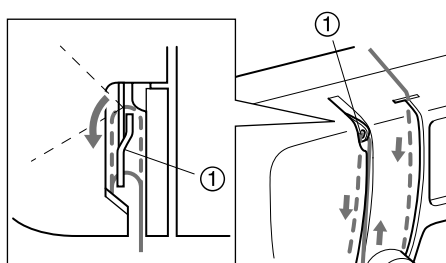

① Thread take-up lever

- 8** Put the thread behind the needle bar thread guide above the needle.

The thread can easily be passed behind the needle bar thread guide by holding the thread in your left hand, then feeding the thread with your right hand.

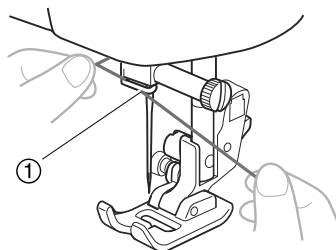

① Needle bar thread guide

- 9** Thread the needle from front to back and pull out about 5 cm (2 inches) of thread.

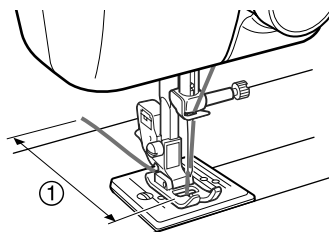

① 5 cm (2 inches)

**Note**

- If the thread take-up lever is lowered, the upper thread cannot be wrapped around the thread take-up lever. Make sure you raise the presser foot lever and the thread take-up lever before you feed the upper thread.
- If you incorrectly feed the thread you may cause sewing problems.

## Drawing up the lower thread

- 1** Lightly hold the end of the upper thread.

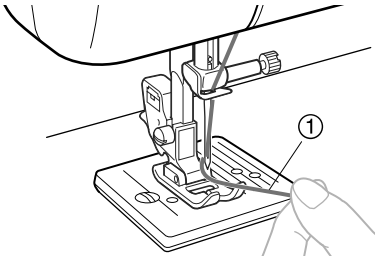

① Upper thread

- 2** While holding the end of the upper thread, raise the needle to its highest position by turning the handwheel toward you (counterclockwise).

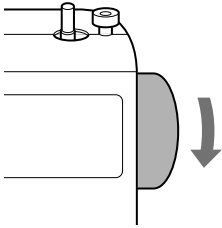

- 3** Pull on the upper thread to draw up the lower thread.

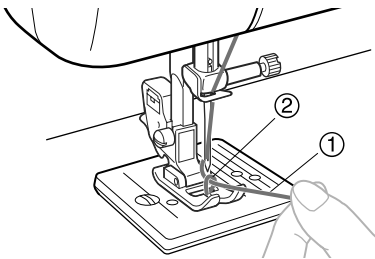

① Upper thread  
② Lower thread

- 4** Pull out about 15 cm (6 inches) of both threads and pull them toward the back of the machine under the presser foot.

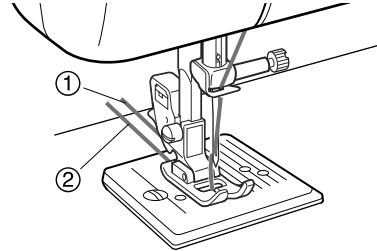

① Upper thread  
② Lower thread

## REPLACING THE NEEDLE

This section provides information on sewing machine needles.

### Needle precautions

Be sure to observe the following precautions concerning the handling of the needle. Failure to observe these precautions is extremely dangerous. Be sure to read and carefully follow the instructions below.

#### CAUTION

- Only use home sewing machine needles. Use of any other needle may bend the needle or damage the machine.
- Never use bent needles. Bent needles can easily break, possibly resulting in injury.

### Selecting the needle depending on the thread and fabric types

The sewing machine needle that should be used depends on the fabric and thread thickness. Refer to the following table when choosing the thread and needle appropriate for the fabric that you wish to sew. Use the same size thread for the upper (spool) and lower (bobbin) threads.

Sewing fabrics		Needle sizes	Thread sizes
Very thin	Fine tricot, Fine lace, Thin linen, Silk, Organza, Chiffon	65/9	Cotton: 80 Synthetic/ Polyester Long Fiber Fine Mercerized Cotton
Lightweight	Voile, Taffeta, Synthetics, Silk, Batiste	75/11	Cotton: 60-80 Silk: "A" Synthetic/ Polyester Long Fiber Mercerized 50
Medium weight	Cotton, Gingham, Poplin, Percalé, Pique, Satin, Velvet, Lightweight wool, Fine corduroy, Suitings, Linen, Muslin	90/14 (Supplied with your machine.)	Cotton: 50-60 Silk: "A" Synthetic/ Polyester Long Fiber Mercerized 50-60
Heavyweight	Denim, Gabardine, Tweed, Corduroy, Canvas, Duck	100/16	Cotton: 40-50 Mercerized Heavy Duty Polyester Long Fiber
Knits	Single knit, Double knit, Jersey, Tricot	90/14 (Ball point)	Cotton Wrapped Polyester Polyester Long Fiber



#### Memo

- The smaller the thread number, the thicker the thread; and the larger the needle number, the thicker the needle.
- Use the ball point needle when sewing on stretch fabrics or fabrics where skipped stitches easily occur.
- Use a 90/14 to 100/16 needle with transparent nylon threads, regardless of the fabric being sewn.
- A 75/11 needle is already installed when the sewing machine is purchased.

**CAUTION**

● The appropriate fabric, thread and needle combinations are shown in the table on the previous page. If the combination of the fabric, thread and needle is not correct, particularly when sewing thick fabrics (such as denim) with thin needles (such as 65/9 to 75/11), the needle may bend or break. In addition, the stitching may be uneven or puckered or there may be skipped stitches.

**Checking the needle**

Sewing with a bent needle is extremely dangerous since the needle may break while the machine is being operated.

Before using the needle, place the flat side of the needle on a flat surface and check that the distance between the needle and the flat surface is even.

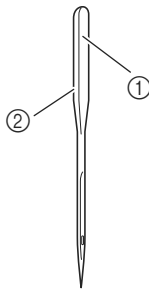

- ① Flat side
- ② Needle type marking

■ **Correct needle**

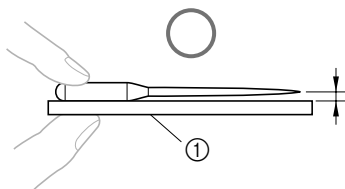

- ① Flat surface

■ **Incorrect needle**

If the distance between the needle and the flat surface is not even, the needle is bent. Do not use a bent needle.

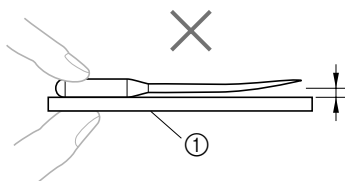

- ① Flat surface

**Replacing the needle**

Replace the needle as described below. Use the screwdriver and a needle that has been determined to be straight according to the instructions in "Checking the needle".

- 1 Turn off the sewing machine.

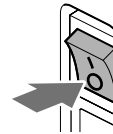

**CAUTION**

● Before replacing the needle, be sure to turn off the sewing machine, otherwise injuries may occur if the foot controller is accidentally pressed and the machine starts sewing.

- 2 Raise the needle to its highest position by turning the handwheel toward you (counterclockwise).

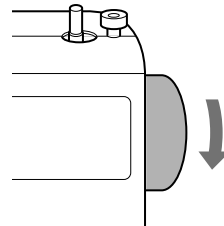

- 3 Lower the presser foot lever.

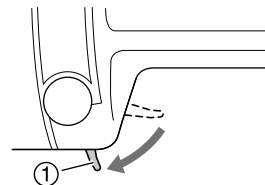

- ① Presser foot lever

- 4** Hold the needle with your left hand, and then use a screwdriver to turn the needle clamp screw counterclockwise to remove the needle.



**Note**

- The needle can be removed by simply loosening the needle clamp screw about one turn. (If the needle clamp screw is loosened too much, the needle clamp (which holds the needle) may fall off. Therefore, do not loosen the needle clamp screw too much.)

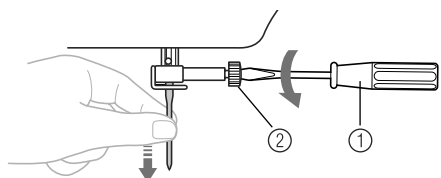

- ① Screwdriver
- ② Needle clamp screw

- Do not apply strong force when loosening or tightening the needle clamp screw, otherwise certain parts of the sewing machine may be damaged.

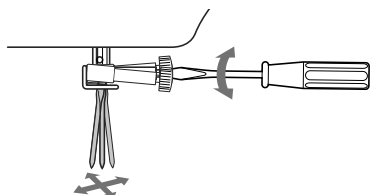

- 5** With the flat side of the needle toward the rear of the machine, insert the needle until it touches the needle stopper.

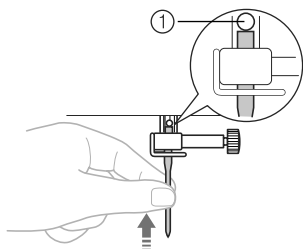

- ① Needle stopper

- 6** While holding the needle with your left hand, use the screwdriver to tighten the needle clamp screw by turning it clockwise.

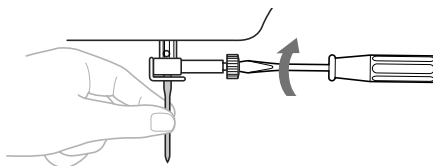

Install the twin needle in the same way.

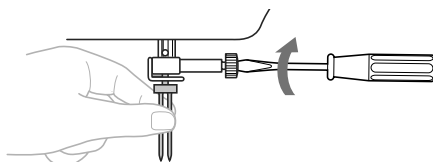

**CAUTION**

- Be sure to insert the needle until it touches the needle stopper and securely tighten the needle clamp screw with the screwdriver, otherwise the needle may break or damage may result.

**Installing the needle clamp**

If the needle clamp is removed, follow the procedure below to attach it to the needle bar.

- 1** As seen from the front of the machine, slide the needle clamp onto the needle bar so that the needle clamp screw is on the right side and the needle bar thread guide is at the bottom.

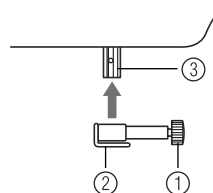

- ① Needle clamp screw
- ② Needle bar thread guide
- ③ Needle bar

- 2** Align the bottom edge of the needle holder with the end of the needle bar, and then tighten the needle clamp screw.

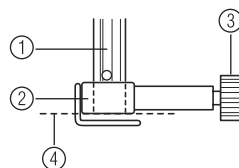

- ① Needle bar
- ② Needle holder
- ③ Needle clamp screw
- ④ Align

## Sewing with a twin needle (Option)

We have designed your machine so you can sew with the optional twin needle and two top threads. You can use the same color or two different colors of thread for making decorative stitches.

The stitches available for twin-needle sewing are straight stitches 6 through 10 and zigzag stitch 2.

### CAUTION

- Use only twin needles that have been made for this machine (part code: X57521-021). Other needles could break, and damage the machine.
- Do not sew with bent needles. The needle could break and injure you.
- When using the twin needle, be sure to select an appropriate stitch (straight stitches 6 through 10 and zigzag stitch 2), otherwise the needle may break or the machine may be damaged.
- Slowly turn the handwheel toward you (counterclockwise) and check that the needle does not touch the presser foot. If the needle hits the presser foot, the needle may bend or break.
- When changing the sewing direction, be sure to raise the needle before turning the fabric. If the fabric is turned while the needle is lowered, the needle may bend or break.

### ■ Twin needle threading

- 1 Attach the twin needle.**  
Attach the twin needle in the same way as a single needle (page 20).
- 2 Attach the extra spool pin.**  
Put the extra spool pin in the hole on the top of the machine. Put the second spool of thread onto the extra spool pin.

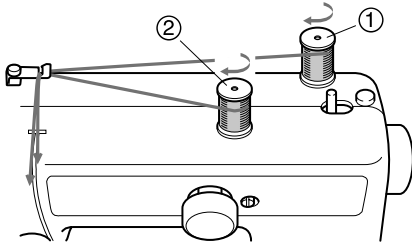

- ① First spool
- ② Second spool

- 3 Use the thread from the first spool to thread the machine to the needle bar thread guide.**  
The path for threading the machine to the needle bar thread guide is the same as for normally threading the machine (for a single needle). See page 16 for more details.
- 4 Thread the left needle from front to back.**
- 5 Use the thread from the second spool to thread the machine to the thread take-up lever.**  
The path for threading the machine to the thread take-up lever is the same as for normally threading the machine (for a single needle). See page 16 for more details.

- 6 Thread the right needle from front to back.**  
Do not pass the thread behind the needle bar thread guide.

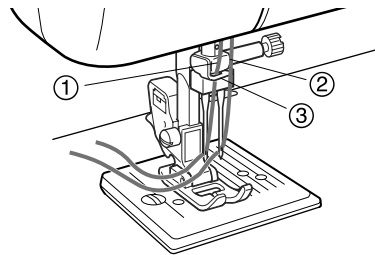

- ① Left needle thread passes through the needle bar thread guide.
- ② Right needle thread passes in front of the needle bar thread guide.
- ③ Needle bar thread guide



## REPLACING THE PRESSER FOOT

### CAUTION

- Always turn off the power before you change the presser foot. If you leave the power on and step on the controller, the machine will start and you may be injured.
- Always use the correct presser foot for the stitch pattern you have chosen. If you use the wrong presser foot, the needle may strike the presser foot and bend or break, and may cause injury.
- Only use presser feet that have been designed to be used with this machine. Using other any presser feet may cause an accident or injury.

### Replacing the presser foot

Replace the presser foot as described below.

- 1 If the sewing machine has been turned on, turn it off.



### CAUTION

- Before replacing the presser foot, be sure to turn off the sewing machine, otherwise injuries may occur if the foot controller is accidentally pressed and the machine starts sewing.

- 2 Raise the needle to its highest position by turning the handwheel toward you (counterclockwise).

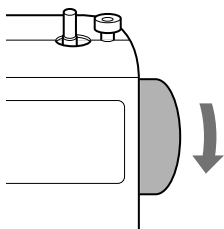

- 3 Raise the presser foot lever.

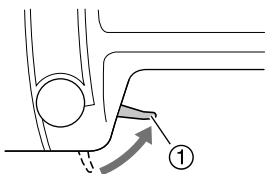

① Presser foot lever

- 4 Press the black button at the back of the presser foot holder to release the presser foot.

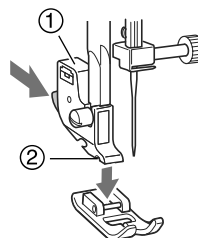

- ① Black button
- ② Presser foot holder

- 5 Place a different presser foot below the holder so that the presser foot pin is aligned with the shank in the holder.

Position the presser foot so the letter indicating the presser foot type (A, I, etc.) is positioned to be read.

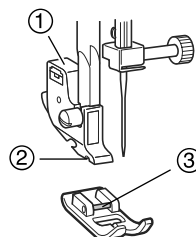

- ① Presser foot holder
- ② Shank
- ③ Pin

- 6 Slowly lower the presser foot lever so that the presser foot pin snaps into the shank in the presser foot holder.

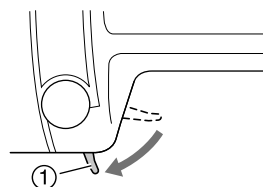

- ① Presser foot lever
- ▶ The presser foot is attached.

- 7** Raise the presser foot lever to check that the presser foot is securely attached.

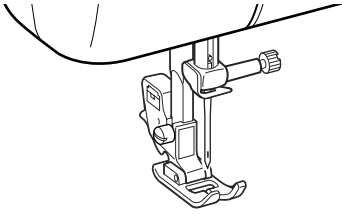

## Removing the presser foot holder

Remove the presser foot holder when cleaning the sewing machine or when installing a presser foot that does not use the presser foot holder, such as the quilting foot. Use the screwdriver to remove the presser foot holder.

### ■ Removing the presser foot holder

- 1** Remove the presser foot.
  - For details, refer to “Replacing the presser foot” (page 23).
- 2** Use the screwdriver to loosen the presser foot holder screw.

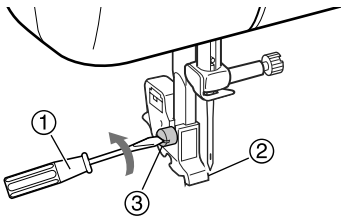

- ① Screwdriver
- ② Presser foot holder
- ③ Presser foot holder screw

### ■ Attaching the presser foot holder

- 1** Align the presser foot holder with the lower-left side of the presser bar.

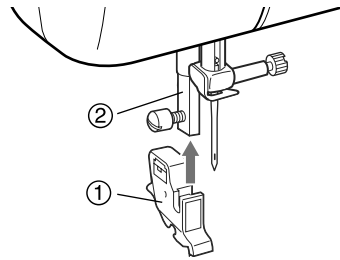

- ① Presser foot holder
- ② Presser bar

- 2** Hold the presser foot holder in place with your right hand, and then tighten the screw using the screwdriver in your left hand.

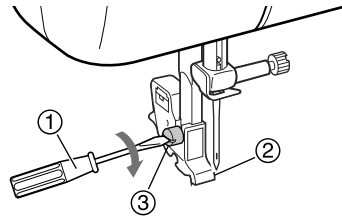

- ① Screwdriver
- ② Presser foot holder
- ③ Presser foot holder screw



### Note

- If the presser foot holder is not correctly installed, the thread tension will be incorrect.

## 2 SEWING BASICS

### SEWING

Basic sewing operations are described below.  
Before operating the sewing machine, read the following precautions.

#### CAUTION

- While the machine is in operation, pay special attention to the needle location. In addition, keep your hands away from all moving parts such as the needle and handwheel, otherwise injuries may occur.
- Do not pull or push the fabric too hard while sewing, otherwise injuries may occur or the needle may break.
- Never use bent needles. Bent needles can easily break, possibly resulting in injuries.
- Make sure that the needle does not strike basting pins, otherwise the needle may break or bend.

### General sewing procedure

Follow the basic procedures below to sew.

**1 Turn on the machine.**

Turn on the sewing machine.  
For details on turning on the machine, refer to "Power supply" (page 10).



**2 Select the stitch.**

Select the stitch appropriate for the area to be sewn.  
For details on selecting a stitch, refer to "Selecting stitching" (page 26).



**3 Attach the presser foot.**

Attach the presser foot appropriate for the stitch.  
For details on replacing the presser foot, refer to "Replacing the presser foot" (page 23).



**4 Start sewing.**







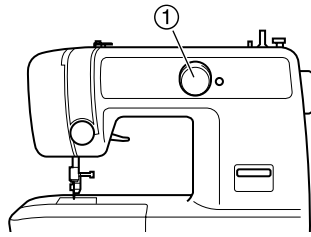

Position the fabric, and then start sewing. When sewing is finished, cut the threads.  
For details on starting to sew, refer to "Starting to sew" (page 27).

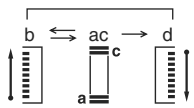
## Selecting stitching

Turning the stitch selection dial in either direction, select the desired stitch.

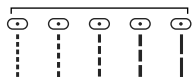

①Pattern selection dial

Number on dial	Stitch name	Pattern	Page
1	4-step automatic buttonhole		36
2	Zigzag stitch		32, 41
3	Zigzag stitch		
4	Zigzag stitch		
5	Zigzag (satin) stitch		
6	Straight stitch (Center needle position)	 Select the desired length.	33, 35, 40, 43
7	Straight stitch (Left needle position)		33
8	Stretch blind Stitch		33
9	Shell tuck stitch		43
10	Elastic stitch		44

## Starting to sew

- 1 Turn on the sewing machine.



- 2 Raise the needle to its highest position by turning the handwheel toward you (counterclockwise).

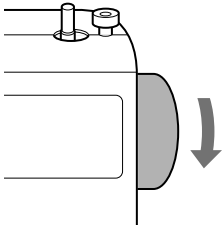

- 3 Raise the presser foot lever.

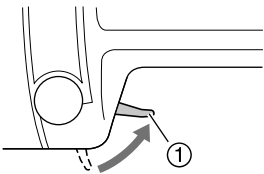

① Presser foot lever

- 4 Place the fabric under the presser foot, pass the thread under the presser foot, and then pull out about 5 cm (2 inches) of thread toward the rear of the machine.

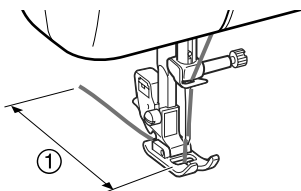

① 5 cm (2 inches)

- 5 While holding the end of the thread and the fabric with your left hand, turn the handwheel toward you (counterclockwise) with your right hand to lower the needle to the starting point of the stitching.

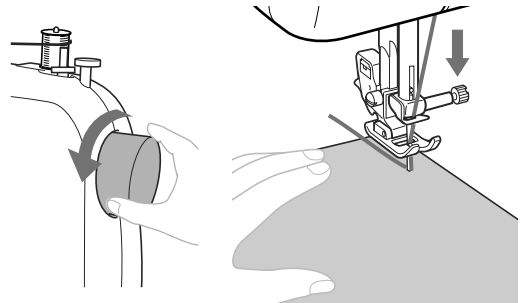

- 6 Lower the presser foot lever.

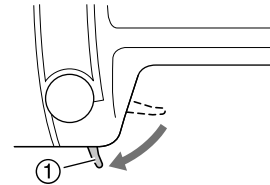

① Presser foot lever

- 7 Slowly press down on the foot controller.

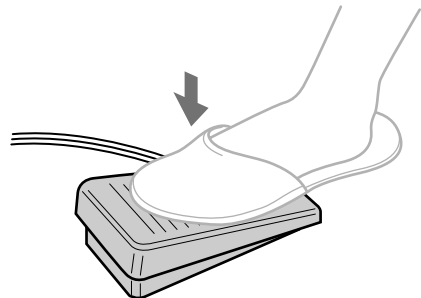

► The machine starts sewing.

- 8 Take your foot off the foot controller.

► The machine stops sewing.

- 9 Raise the needle to its highest position by turning the handwheel toward you (counterclockwise).

- 10 Raise the presser foot lever.

- 11** Pull the fabric to the left side of the machine, and then pass the threads through the thread cutter on the back of the presser foot bar to cut them.

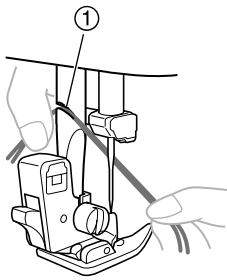

① Thread cutter

## Sewing in reverse

Reverse sewing is used to lock the threads at the end of the seam or wherever reinforcement is needed.

- 1** Press and hold down the reverse sewing lever while sewing.

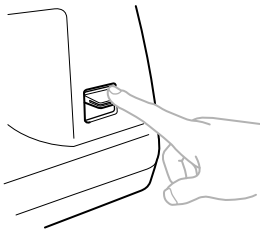

- 2** To sew forward, release the reverse sewing lever.

## Thread tension

The thread tension will affect the quality of your stitches. You may need to adjust it when you change fabric or thread.



### Memo

- Before beginning to change tension adjustments make sure the upper thread and bobbin are inserted correctly.
- We recommend you do a test sample on a scrap of fabric before you start to sew.

### Correct tension

Correct tension is important as too much or too little tension will weaken your seams or cause puckers on your fabric.

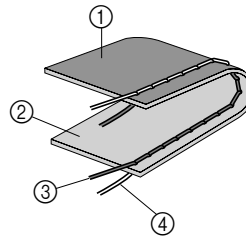

- ① Wrong side
- ② Surface
- ③ Upper thread
- ④ Lower thread

### Upper tension is too tight

Loops appear on the surface of the fabric.



### Note

- If the bobbin thread was incorrectly inserted, the upper thread may be too tight. In this case, refer to “Lower threading” (page 14) and reinsert the bobbin.

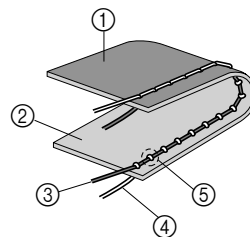

- ① Wrong side
- ② Surface
- ③ Upper thread
- ④ Lower thread
- ⑤ Loops appear on surface of fabric

### Solution

Reduce the tension by turning the upper tension-control dial to a lower number.

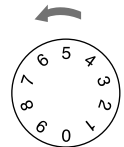

## ■ Upper tension is too loose

Loops appear on the wrong side of the fabric.



### Note

- If the upper thread was incorrectly threaded, the upper thread may be too loose. In this case, refer to “Upper threading” (page 16) and rethread.

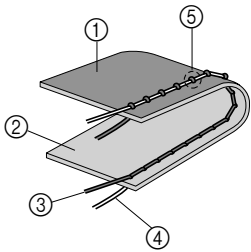

- ① Wrong side
- ② Surface
- ③ Upper thread
- ④ Lower thread
- ⑤ Loops appear on wrong side of fabric

### Solution

Increase the tension by turning the upper tension-control dial to a higher number.

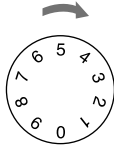

## ■ Bobbin tension is too loose

Loops may appear on the surface of the fabric when sewing thin fabric with thin thread.

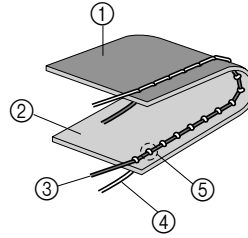

- ① Wrong side
- ② Surface
- ③ Upper thread
- ④ Lower thread
- ⑤ Loops appear on surface of fabric

### Solution

Reduce the tension by turning the upper tension-control dial to a lower number.

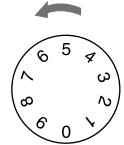

If the problem persists, increase the tension in the bobbin by turning the screw clockwise with a small screwdriver.

Be sure not to turn the screw more than one full turn. In addition, be sure to return the screw to its original position before the next time that the machine is used.



### Note

- The bobbin thread tension has been adjusted at the factory for general use. For most sewing applications, no adjustment is needed.

## USEFUL SEWING TIPS

Various ways to achieve better results for your sewing projects are described below. Refer to these tips when sewing your project.

### Trial sewing

A trial piece of fabric should be sewn since, depending on the type of fabric and stitching being sewn, the desired results may not be achieved.

For the trial sewing, use a piece of fabric and thread that are the same as those used for your project, and check the thread tension and stitch length and width. Since the results differ depending on the type of stitching and the number of layers of fabric sewn, perform the trial sewing under the same conditions that will be used with your project.

### Changing the sewing direction

#### 1 When the stitching reaches a corner, stop the sewing machine.

Leave the needle lowered (in the fabric). If the needle was raised, lower the needle by turning the handwheel toward you (counterclockwise).

#### CAUTION

- When using the twin needle, be sure to raise the needle before changing the sewing direction. If the fabric is turned while the needle is lowered, the needle may bend or break.

#### 2 Raise the presser foot lever, and then turn the fabric.

Turn the fabric using the needle as a pivot.

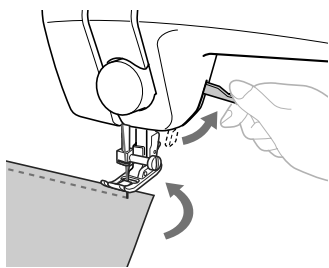

#### 3 Lower the presser foot lever and continue sewing.

### Sewing curves

Stop sewing, and then slightly change the sewing direction to sew around the curve.

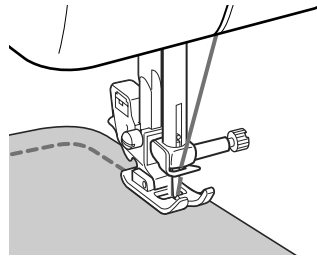

When sewing along a curve while using a zigzag stitch, select a shorter stitch length in order to obtain a finer stitch.

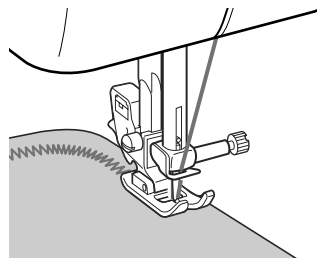

### Sewing thick fabrics

#### ■ If the fabric does not fit under the presser foot

If the fabric does not fit easily under the presser foot, raise the presser foot lever even higher to bring the presser foot to its highest position.

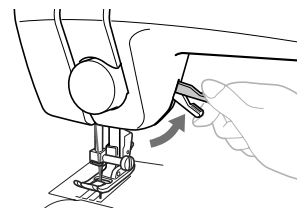

#### CAUTION

- If fabric more than 6 mm (15/64 inches) thick is sewn or if the fabric is pushed with too much force, the needle may bend or break.



## Sewing thin fabrics

When sewing thin fabrics, the stitching may become misaligned or the fabric may not feed correctly. If this occurs, place thin paper or stabilizer material under the fabric and sew it together with the fabric. When you have finished sewing, tear off any excess paper.

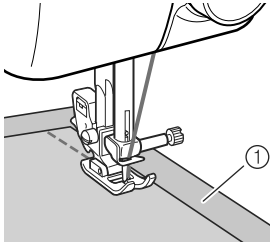

① Stabilizer material or paper

## Sewing stretch fabrics

First, baste the pieces of fabric together, and then sew without stretching the fabric.

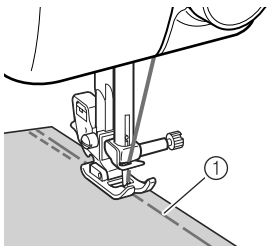

① Basting

## Using a free-arm style

Free-arm sewing is convenient for sewing tubular and hard-to-reach areas.

To change your machine to the free-arm style, lift the bottom of the flat bed attachment toward you, and then pull the flat bed attachment out to remove it.

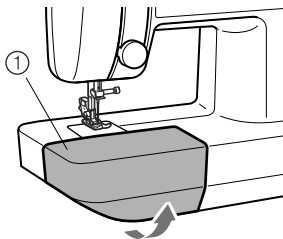





① Flat bed attachment

# 3 UTILITY STITCHES

## USEFUL STITCHES

### Zigzag stitches

You can use the zigzag stitches to join together seams and finish them in one operation. They are also useful for sewing stretch materials.

Number on dial	Stitch name	Application
2 	Zigzag stitch	
3 	Zigzag stitch	Overcasting and attaching appliqués. Select the desired width.
4 	Zigzag stitch	
5 	Zigzag (satin) stitch	Overcasting and attaching appliqués with the decorative satin stitches.

#### 1 Select a stitch.

- For details, refer to “Selecting stitching” (page 26).

#### 2 Lower the needle into the fabric at the beginning of the stitching.

#### 3 Start sawing.

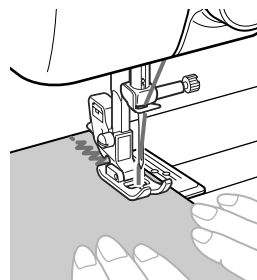

- For details, refer to “Starting to sew” (page 27).



#### Memo

- When sewing with a zigzag stitch, use straight stitches at the beginning and end of the zigzag stitch for reinforcement.

#### 4 When sewing is finished, cut the thread.

- For details, refer to “Starting to sew” (page 27).





#### CAUTION

- Slowly turn the handwheel toward you (counterclockwise) and check that the needle does not touch the presser foot. If the needle hits the presser foot, the needle may bend or break.

## Basic stitching

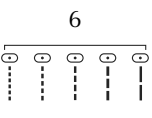
Straight stitches are used for sewing plain seams. Two stitches are available for basic stitching.

Number on dial	Stitch name	Application
6 	<b>Straight stitch (Center needle position)</b>	Attaching zippers, basic stitching, and sewing gathers or darning, etc.
7 	<b>Straight stitch (Left needle position)</b>	Basic stitching, sewing gathers or pintucks, etc.

- 1** Baste or pin together the fabric pieces.
- 2** Select a stitch.
  - For details, refer to “Selecting stitching” (page 26).
- 3** Lower the needle into the fabric at the beginning of the stitching.
- 4** Start sewing.
  - For details, refer to “Starting to sew” (page 27).
- 5** When sewing is finished, cut the thread.
  - For details, refer to “Starting to sew” (page 27).

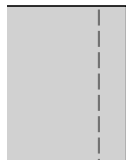

## Blind hem stitching

You can use the Blind Hem Stitch to finish the edge of a project, like the hem of a pair of trousers, without the stitch showing.

Number on dial	Stitch name	Application
8 	<b>Stretch blind Stitch</b>	Blind hem stitching on stretch fabrics.

- 1** Reverse the skirt or pants.



- ① Right side of fabric
- ② Bottom side

- 2** Fold the fabric along the desired edge of the hem, and press.

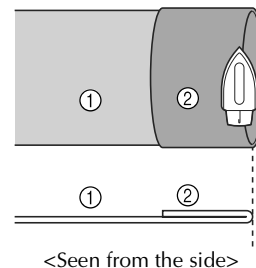

- ① Wrong side of fabric
- ② Right side of fabric

- 3** Use a chalk to mark on the fabric about 5 mm (3/16 inches) from the edge of the fabric, and then baste it.

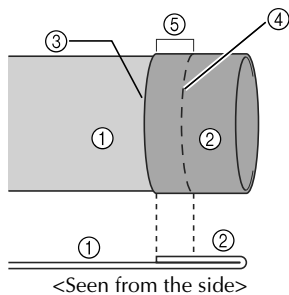

- ① Wrong side of fabric
- ② Right side of fabric
- ③ Edge of fabric
- ④ Basting stitching
- ⑤ 5 mm (3/16 inches)

- 4** Fold back the fabric inside along the basting.

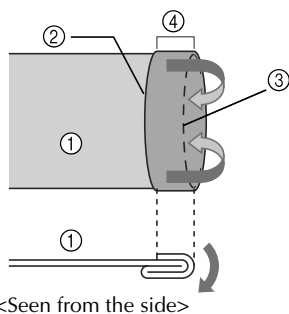

- ① Wrong side of fabric
- ② Edge of fabric
- ③ Basting
- ④ 5 mm (3/16 inches)

- 5** Unfold the edge of fabric, and position the fabric with the wrong side facing up.

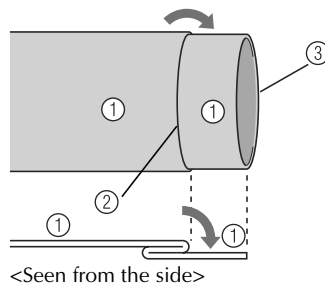

- ① Wrong side of fabric
- ② Basting
- ③ Edge of fabric

- 6** Select the stretch blind stitch (8).

- 7** Remove the flat bed attachment and make free-arm sewing possible.

- For details on free-arm sewing, refer to "Using a free-arm style" (page 31).

- 8** Slide the part that you wish to sew onto the arm, make sure that the fabric feeds correctly, and then start sewing.

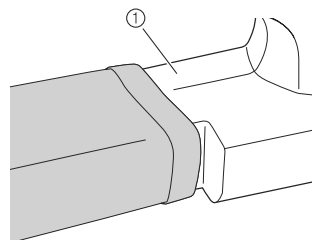

- ① Arm

- 9** Position the fabric so that the needle slightly catches the fold of the hem, and then lower the presser foot lever.

For invisible stitching, make sure that both threads are the same color as the fabric.

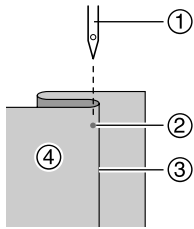

- ① Needle
- ② Needle drop point
- ③ Fold of hem
- ④ Wrong side of fabric

- 10** Sew along the fold of the hem.

- 11** Remove the basting stitching and turn the fabric right side up.

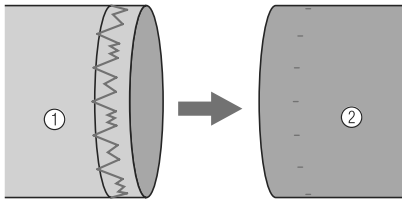

- ① Wrong side of fabric
- ② Right side of fabric

## Darning

Reinforce points that will be subject to strain.

Number on dial	Stitch name	Application
6	Straight stitch (Center needle position)	Attaching zippers, basic stitching, and sewing gathers or darning, etc.

- 1** Place the darning plate on the needle plate as shown below, and then remove both the presser foot and presser foot holder assembly.

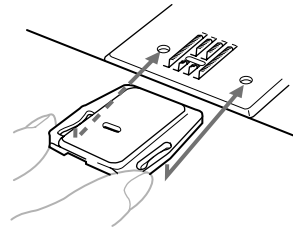

- 2** Select the desired length for straight stitch (6).

- 3** Place the fabric to be darned under the presser foot together with a fabric underlay for reinforcement.

- 4** Start sewing while gently moving the fabric with your hands, alternately drawing the fabric away and pulling it toward you.

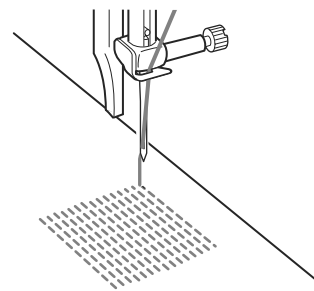

- 5** Stop sewing when the portion to be darned is filled with parallel stitching.

# BUTTONHOLE SEWING

Buttonholes can be sewn and buttons can be sewn on.

Number on dial	Stitch name	Application
1	4-step automatic buttonhole	Buttonholes on medium weight fabrics.

Buttonholes are sewn from the front of the presser foot to the back, as shown below.

Step	Sewn portion
Step a (Front end of button hole)	
Step b (Left side)	
Step c (Back end of button hole)	
Step d (Right side)	

① Reinforcement stitching

## Making the buttonhole

The names of parts of buttonhole foot “A”, which is used for sewing buttonholes, are indicated below.

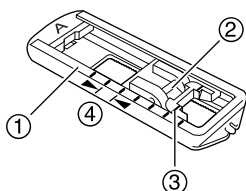

- ① Presser foot scale
- ② Pin
- ③ Marks on buttonhole foot
- ④ 5 mm (3/16 inches)

### Memo

- Before sewing buttonholes, check the stitch length and width by sewing a trial buttonhole on a scrap piece of fabric.
- When sewing buttonholes on stretch fabrics, place stabilizer material under the fabric.

**1** Use chalk to mark the position and length of the buttonhole on the fabric.

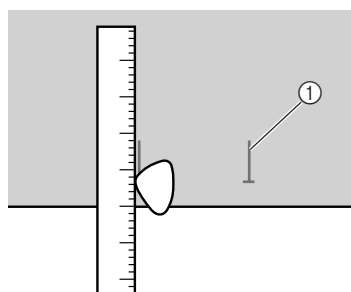

① Marks on fabric

**2** Attach buttonhole foot “A” and push the outside frame back until the sliding insert reaches the front of the outside frame.

**3** Select stitch “a” of the 4-step automatic buttonhole (1).

**4** Position the fabric under the presser foot so that the middle of the front chalk line is directly in the center of the presser foot and aligned with the two red lines on the insert. Pass the upper thread down through the hole in the presser foot.

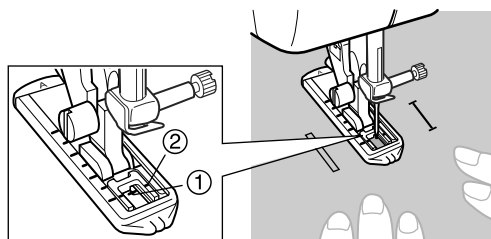

- ① Mark on fabric
- ② Red marks on the sliding insert

**5** Start sewing. Sew 5 to 6 stitches.

- 6 Stop sewing when the needle is at the left side of the stitching, and then raise the needle by turning the handwheel toward you.
- 7 Select stitch "b" of the 4-step automatic buttonhole (1).
- 8 Start sewing, and then sew the length of the chalk line.
- 9 Stop sewing when the needle is at the right side of the stitching, and then raise the needle by turning the handwheel toward you.
- 10 Select stitch "c" (same as "a") of the 4-step automatic buttonhole (1).
- 11 Start sewing. Sew 5 to 6 stitches.
- 12 Stop sewing when the needle is at the right side of the stitching, and then raise the needle by turning the handwheel toward you.
- 13 Select stitch "d" of the 4-step automatic buttonhole (1).
- 14 Start sewing. Sew the right side of the buttonhole until the needle reaches the stitching sewn in step 5.  
For reinforcement, turn the fabric 90 degrees counterclockwise, select the straight stitch (6 through 10) with the desired length, and then sew to the edge of the front bar tack.
- 15 Raise the presser foot lever, remove the fabric, and cut the thread.

- 16 Insert a pin at the end of the buttonhole stitching to prevent the stitching from being cut, and then use a seam ripper to cut towards the pin and open the buttonhole.

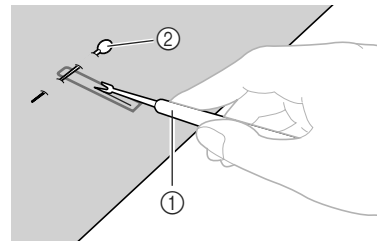

- ① Seam ripper
- ② Pin

### ⚠ CAUTION

- When opening the buttonhole with the seam ripper, do not place your hands in the cutting path, otherwise injuries may result if the seam ripper slips. Do not use the seam ripper in any other way than how it is intended.

## Adjusting button stitching

If the stitching on the two sides of the buttonhole is not uniform, the stitching can be adjusted with the buttonhole fine-adjusting screw.

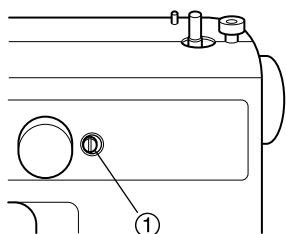

① Buttonhole fine-adjusting screw

■ **If the right side is too loose compared to the left side**

Use the enclosed large screwdriver to turn the buttonhole fine-adjusting screw in the - direction.

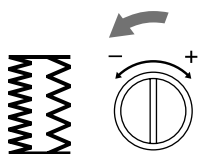

■ **If the right side is too tight compared to the left side**

Use the enclosed large screwdriver to turn the buttonhole fine-adjusting screw in the + direction.

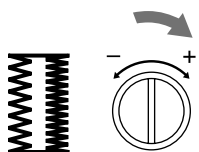

## Button sewing

Buttons can be sewn on with the sewing machine. Buttons with 2 or with 4 holes can be attached.

- 1 Measure the distance between the holes in the button to be attached, and then select the appropriate zigzag stitch (2, 3 or 4) according to the following table.

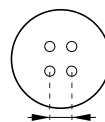

Distance between holes	Number of dial
1.6 mm (1/16 inches)	2
3.2 mm (1/8 inches)	3
4.8 mm (3/16 inches)	4

- 2 Attach the button sewing foot "M".
- 3 Place the darning plate on the needle plate as shown below.

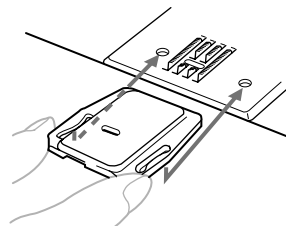

- 4 Place a button between the presser foot and the fabric.

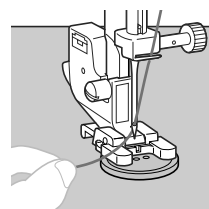

- When attaching four-hole buttons, first sew the two holes closest to you. Then, slide the button so that the needle goes into the two holes toward the rear of the sewing machine, and then sew them in the same way.

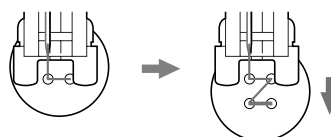



- 5** Turn the handwheel toward you (counterclockwise) to check that the needle correctly goes into the two holes of the button.

If the needle hits the button, return to step 1.

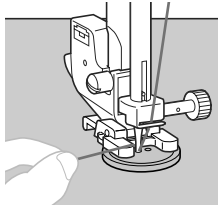

### **!** CAUTION

- When sewing, be sure that the needle does not touch the button, otherwise the needle may bend or break.

- 6** Start sewing.

- After sewing for about 10 seconds at a low speed, press and hold down the reverse sewing lever to sew a few reinforcement stitches.

- 7** Pull the fabric to the left side of the machine, and then cut the upper and lower threads, leaving a length of 15 cm (6 inches).

- 8** Pull the upper thread at the end of the stitching to the wrong side of the fabric, and then tie it with the bobbin thread. Use scissors to cut the upper thread and the bobbin thread at the beginning of the stitching.

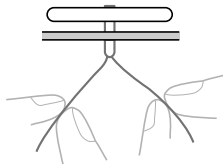

## ZIPPER INSERTION

You can use the zipper foot “1” to sew different types of zippers, and can easily position it to the right or left side of the needle.

When sewing the right side of the zipper, attach the shank to the left pin of the zipper foot. When sewing the left side of the zipper, attach the shank to the right pin of the zipper foot.

Number on dial	Stitch name	Application
6	Straight stitch (Center needle position)	Attaching zippers, basic stitching, and sewing gathers or darning, etc.
		

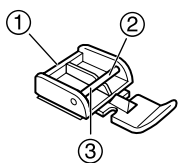

- ① Zipper foot “1”
- ② Right pin for sewing the left side of the zipper
- ③ Left pin for sewing the right side of the zipper

**1** Select the desired length for straight stitch (6).

**2** Lower the presser foot lever and fix either the left or right pin of the zipper foot onto the shank.

**3** Fold the edge of the fabric 2 cm (3/4 inches) and place the zipper under the folded section. Lower the needle into the notch located either on the left or right side of the zipper foot.

### CAUTION

- Turn the handwheel by hand to make sure the needle does not hit the presser foot before you start sewing. If you choose a different stitch, the needle will hit the presser foot and break the needle. You may also be injured.

**4** Sew from the bottom of the zipper toward the top on both sides. The needle should be positioned on the zipper side of the foot for best results.

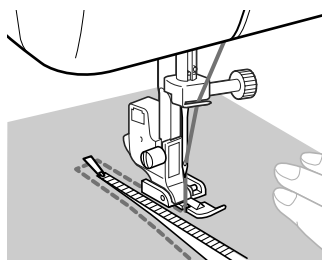





**5** To sew the opposite side of the zipper, release the foot by pressing the button located at the back of the presser foot, fit the zipper foot on the other side of the zipper and continue sewing using the other side notch.

### CAUTION

- Make sure the needle does not hit the zipper during sewing. If the needle hits the zipper, the needle may break and you may be injured.

## APPLIQUÉ, MONOGRAMMING AND EMBROIDERING

Zigzag stitches can be used for sewing appliqués, monogramming and embroidering.

Number on dial	Stitch name	Application
2 	Zigzag stitch	
3 	Zigzag stitch	
4 	Zigzag stitch	
5 	Zigzag (satin) stitch	Overcasting and attaching appliqués with the decorative satin stitches.

### Appliqués

You can create an appliqué by cutting a different piece of fabric into a shape and using it as a decoration.

- 1 Baste the cut design to the fabric.
- 2 Select a stitch.

- 3 Carefully sew around the edge of the design.

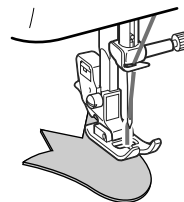

#### Memo

- Make reinforcing straight stitches at the beginning and the end of stitching.

### CAUTION

- Be careful that the needle does not hit a pin during sewing, as the needle can break. You may also be injured.

- 4 Cut away any fabric that is left outside the stitching.

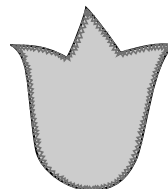

- 5 Remove the basting, if necessary.

### Monogramming and embroidering

- 1 Place the darning plate on the needle plate as shown below, and then remove both the presser foot and presser foot holder assembly.

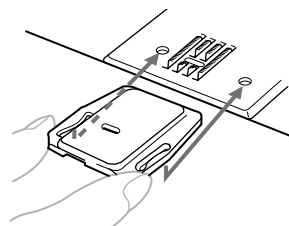

- 2 Select a stitch.
- 3 Draw the lettering (for monogramming) or design (for embroidering) on the surface of the fabric.
- 4 Put the fabric in the embroidery hoop with the surface of the fabric facing up inside the well.
- 5 Place the project under the needle and lower the presser bar.
- 6 Draw up the lower thread through the project at the starting position by turning the handwheel toward you (counterclockwise), and then sew a few stitches to reinforce the stitching.

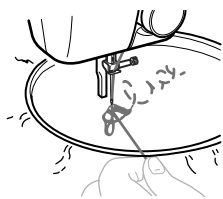

- 7 Grip the hoop with the thumbs and forefingers of both hands while pressing the fabric with the middle and third fingers, and support the outside of the hoop with your little fingers.



- 8 Start sewing.

### CAUTION

- Be sure to keep your fingers away from moving parts, especially needles.

#### ■ Monogramming

Sew the lettering at a constant speed by moving the hoop slowly.

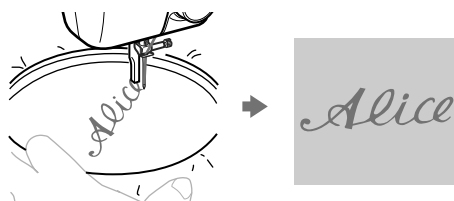

#### ■ Embroidering

Sew along the outline of the design by moving the hoop slowly.

Then, sew to completely fill in the design with stitches by alternately sewing from the outline of the design to the inside and from the inside to the outline.

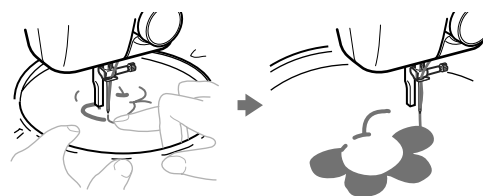

#### 🔔 Memo

- Be sure to keep the stitches close together.

- 9 Select the desired length for straight stitch (6) and sew a few stitches for reinforcing.

#### 🔔 Memo

- When the hoop is moved quickly, the stitches are longer. When the hoop is moved slowly, the stitches are shorter.

# DECORATIVE STITCHING

Various decorative stitches can be sewn with this sewing machine.

## Gathering

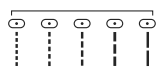
Number on dial	Stitch name	Application
6 	<b>Straight stitch (Center needle position)</b>	Attaching zippers, basic stitching, and sewing gathers or darning, etc.

- 1** Select the desired length for straight stitch (6).
- 2** Loosen the tension of the upper thread (to about 2).
  - For details, refer to “Thread tension” (page 28).
- 3** Sew a single or multiple parallel rows of stitches.
  - Do not sew reverse stitches or cut the thread.
- 4** Pull the bobbin threads to create gathers. Smooth the gathers by ironing them.

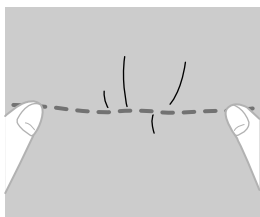

## Shell tuck stitching

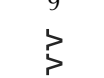
Number on dial	Stitch name	Application
9 	<b>Shell tuck stitch</b>	Shell tuck stitching

The gathers that look like shells are called “shell tucks”. They are used to decorate trims, the front of blouses or cuffs made of thin fabrics.

- 1** Fold the fabric along the bias.

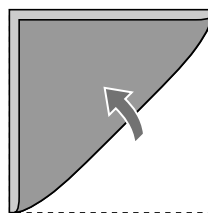

- 2** Select the shell tuck stitch (9), and increase the thread tension.
  - For details, refer to “Selecting stitching” (page 26).
- 3** Sew while making sure that the needle drops slightly off the edge of the fabric.

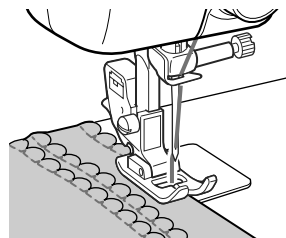

- 4** Unfold the fabric, and then iron the tucks down to one side.

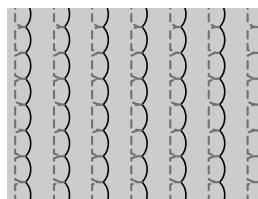

## Elastic stitching

Number on dial	Stitch name	Application
10 	<b>Elastic stitching</b>	Mending, sewing elastic tape or joining fabric.

The elastic stitch can be used in 3 ways: mending, sewing elastic or joining fabric. Each is explained below.

Select the elastic stitch (10).

### ■ Mending

Place the reinforcement fabric under the tear to be mended, and then sew over the tear.



### ■ Sewing elastic tape

Place the elastic tape on the fabric, and then sew over the elastic tape while holding the tape both in front and behind the presser foot.

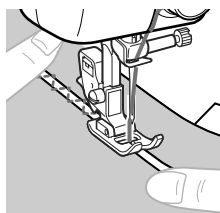

### ■ Joining fabric

Put the edges of the two pieces of fabric together, and then place them under the presser foot with the fabric edges under the center of the presser foot.

Then, start sewing the edges of the two fabrics together.

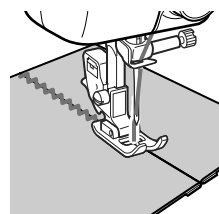

### Memo

- Make reinforcing reverse stitches at the beginning and the end of stitching.

# 4 APPENDIX

## MAINTENANCE

Simple sewing machine maintenance operations are described below.

### Oiling

- 1 Turn off the machine and unplug it.
- 2 Put 2 to 3 drops of oil at each of the points indicated below.  
Be sure to wipe any excess oil off the machine.

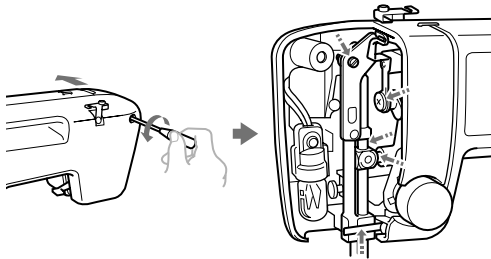
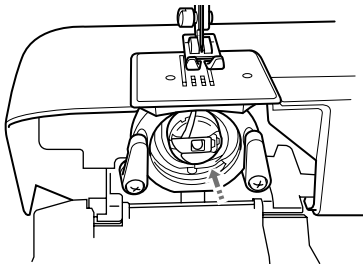

- 3 After oiling, run the machine for a short time at a fast speed without thread.



#### Memo

- Make sure to oil the machine once a week if you use it more than an hour a day. If you use it more often, oil every day.
- Sewing machine oil is available at your local sewing machine dealer or service center.
- Do not apply too much oil as it may soil the thread and fabric.

### Changing the bulb

#### CAUTION

- Unplug the power supply cord before changing the bulb, otherwise injuries or an electric shock may occur.

- 1 Turn off the machine and unplug it.
- 2 Loosen the face plate screw.
- 3 Remove the face plate from the machine.

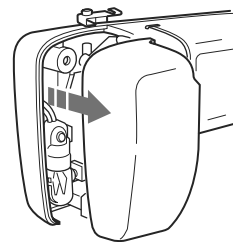
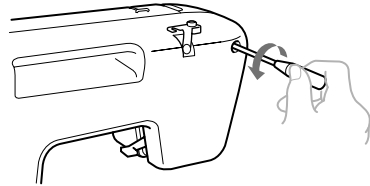

#### Note

- Hold the face plate securely while removing or attaching it.

#### 4 Replace the sewing light bulb.

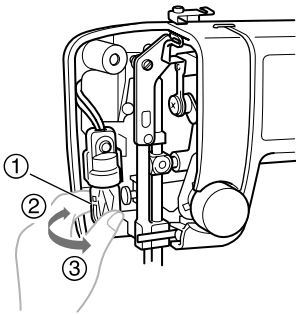

- ① bulb
- ② Loosen
- ③ Tighten

#### 5 Attach the face plate and fasten the screw again.

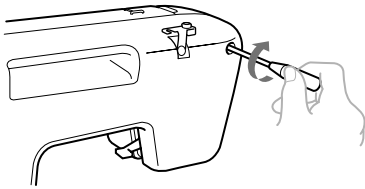

### Cleaning the machine surface

If the surface of the machine is dirty, lightly soak a cloth in neutral detergent, squeeze it out firmly, and then wipe the surface of the machine. After cleaning it once with a wet cloth, wipe it again with a dry cloth.

#### CAUTION

- Unplug the power supply cord before cleaning the machine, otherwise injuries or an electric shock may occur.

### Cleaning the shuttle race

#### CAUTION

- Be sure to unplug the machine before cleaning it, otherwise injuries or an electric shock may occur.

- 1 Turn off the machine and unplug it.
- 2 Raise the needle and the presser foot, and then remove the presser foot and the needle.
- 3 Remove the flat bed attachment and open the shuttle cover at the front of the free arm.
- 4 Remove the bobbin case by pulling its latch toward you and pulling it out from the shuttle race.

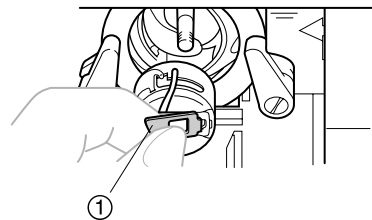

- ① Bobbin case latch

- 5 Slide the latch levers out from the retaining ring to remove it.

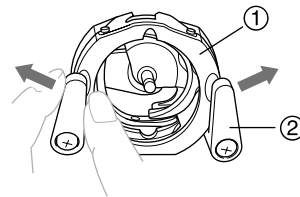

- ① Retaining ring
- ② Latch lever



- 6** Remove the hook by grasping its center post and pulling it out.

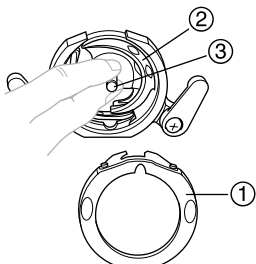

- ① Retaining ring
- ② Hook
- ③ Hook center post

- 7** Use a brush to remove any accumulated lint and thread from the retaining ring, hook, driver and race body.

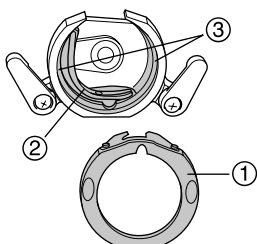

- ① Retaining ring
- ② Driver
- ③ Race body

- 8** Use a cloth dampened with machine oil to wipe the shuttle race in order to remove any lint.

- 9** Clean the lint from the shuttle hook in the same manner as described in step 8.

- 10** Reassemble the hook and the retaining ring, and push the latch levers back into position.

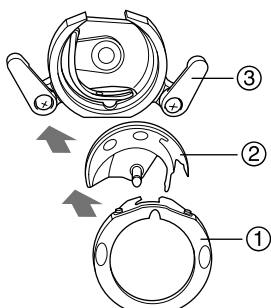

- ① Retaining ring
- ② Hook
- ③ Latch lever

- 11** Attach the bobbin case, the presser foot and the needle before using the machine.

## Cleaning the feed dogs

### ! CAUTION

- Make sure you unplug the machine before you clean it. Otherwise, you may get an electric shock or be injured.

- 1** Turn off the machine and unplug it.

- 2** Raise the needle and the presser foot, and then remove the presser foot and the needle.

- 3** Remove the flat bed attachment and open the shuttle cover at the front of the free arm.

- 4** Remove the needle plate by using a coin or screwdriver to remove the screws.

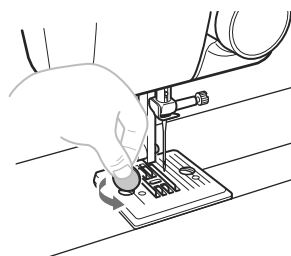

- 5** Use a brush to clean the lint from the upper part of the feed dogs and shuttle race body.

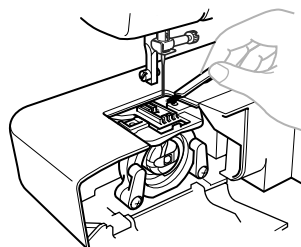

- 6** Attach the needle plate by using a coin or screwdriver.

4

## Repacking the machine

Keep the carton and packing materials for future use. When packing up the machine again, pack it properly as described below. If it is not packed properly, damage may occur during shipping.

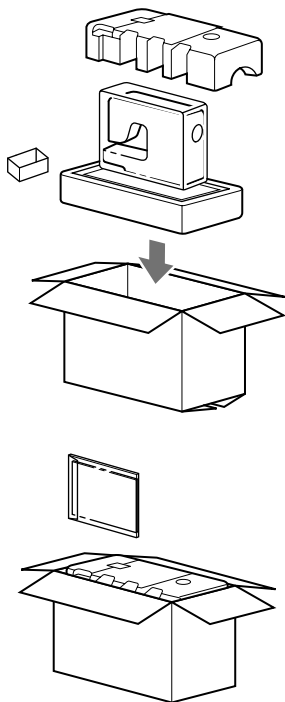

### **!** IMPORTANT

- This packing material is designed to prevent damage in transit.
- Save this packing material in case it is needed to transport this sewing machine.

## Bobbin case tension adjustment

The bobbin thread tension has already been adjusted at the factory for general use. For most sewing applications, no adjustment is needed. When sewing with thin thread on thin fabrics, the thread tension may not be adjusted adequately with the upper tension control dial. Therefore, the thread tension must be adjusted according to the procedure described below.

### **Note**

- Remember to return the screw to its original setting before starting your next project.

### ■ Bobbin tension is too loose

Loops appear on the surface of the fabric.

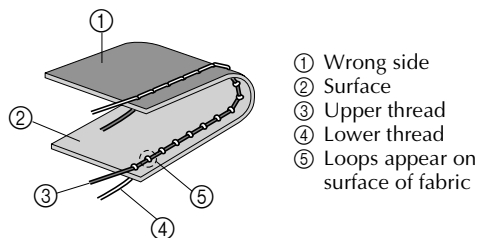

### Solution

Reduce the tension by turning the upper tension-control dial to a lower number.



### **Note**

- If the loops still appear on the surface of the fabric after you adjust the upper tension, the bobbin thread may be too loose. In this case, turn the screw clockwise, being careful not to over-tighten the screw, approximately 30-45 degrees to increase bobbin tension. After you adjust the bobbin thread, adjust the upper thread to match the bobbin thread.

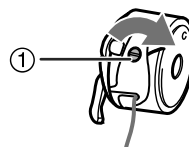

① Screw

## ■ Bobbin tension is too tight

Loops appear on the wrong side of the fabric.

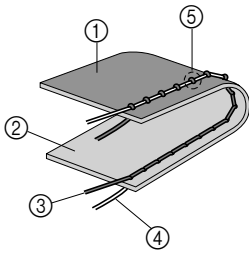

- ① Wrong side
- ② Surface
- ③ Upper thread
- ④ Lower thread
- ⑤ Loops appear on wrong side of fabric

### Solution

Increase the tension by turning the upper tension-control dial to a higher number.

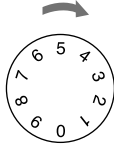

### **Note**

- If the loops still appear on the wrong side of the fabric after you adjust the upper tension, the bobbin thread may be too tight. In this case, turn the screw counterclockwise being careful not to over-loosen the screw, approximately 30-45 degrees to decrease bobbin tension. After you adjust the bobbin thread, adjust the upper thread to match the bobbin thread.

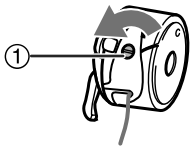

- ① Screw

## TROUBLESHOOTING

If the machine stops operating correctly, check the following possible problems before requesting service. You can solve most problems by yourself. If you need additional help, the Brother Solutions Center offers the latest FAQs and troubleshooting tips. Visit us at [<http://solutions.brother.com>].

If the problem persists, contact your dealer or the nearest authorized service center.

Symptom	Possible cause	How to put it right	Reference
<b>The sewing machine does not work.</b>	The machine is not plugged in.	Plug the machine in.	page 10
	The main power switch is turned off.	Turn on the main power switch.	page 10
	The bobbin winder shaft is pushed to the right.	Move the bobbin winder shaft to the left.	page 13
	You have not used the foot controller properly.	Use the foot controller properly.	page 11
<b>The needle breaks.</b>	You have not inserted the needle properly.	Insert the needle properly.	page 20
	The needle clamp screw is loose.	Use the screwdriver to firmly tighten the screw.	page 21
	The needle is bent or blunt.	Replace the needle.	page 20
	You have not used the right combination of fabric, thread and needle.	Choose a thread and needle that are appropriate for the type of fabric.	page 19
	The presser foot you are using is not appropriate for the type of stitch that you want to sew.	Attach the presser foot that is correct for the type of stitch that you want to sew.	page 35, 36, 38, 40, 41
	The upper thread tension is too tight.	Loosen the upper thread tension.	page 28
	You are pulling the fabric too much.	Lightly guide the fabric.	–
	The area around the hole in the needle plate is scratched.	Replace the needle plate. Contact your retailer or the nearest authorized service center.	–
	The area around the hole in the presser foot is scratched.	Replace the presser foot. Contact your retailer or the nearest authorized service center.	–
	The bobbin case is scratched.	Replace the bobbin case. Contact your retailer or the nearest authorized service center.	–
You have not used a bobbin that has been designed for this machine.	Incorrect bobbins will not work properly. Only use a bobbin that has been designed for this machine.	page 12	
<b>The upper thread breaks.</b>	You have not threaded the upper thread properly. (for example, you have not fitted the spool properly, or the thread has come out of the guide above the needle.)	Correct the upper threading.	page 16
	There are knots or tangles in the thread.	Remove any knots or tangles.	–
	The needle is not appropriate for the thread you are using.	Choose a needle that is appropriate for the type of stitch.	page 19
	The upper thread tension is too tight.	Loosen the upper thread tension.	page 28
	The thread is tangled, for example, in the shuttle race.	Remove the tangle thread. If the thread is tangled in the shuttle race, clean the shuttle race.	page 46

Symptom	Possible cause	How to put it right	Reference
<b>The upper thread breaks.</b>	The needle is bent or blunt.	Replace the needle.	page 20
	You have not inserted the needle properly.	Insert the needle properly.	page 20
	The area around the hole in the needle plate is scratched.	Replace the needle plate. Contact your retailer or the nearest authorised service center.	–
	The area around the hole in the presser foot is scratched.	Replace the presser foot. Contact your retailer or the nearest authorised service center.	–
	The bobbin case is scratched, or has a burr on it.	Replace the bobbin case. Contact your retailer or the nearest authorised service center.	–
	You have not used a bobbin that has been designed for this machine.	Incorrect bobbins will not work properly. Only use a bobbin that has been designed for this machine.	page 12
<b>The lower thread is tangled or breaks.</b>	You have not wound the bobbin thread properly.	Wind the bobbin thread properly.	page 12
	The bobbin is scratched or does not turn smoothly.	Replace the bobbin.	–
	The thread is tangled.	Remove the tangled thread and clean the shuttle race.	page 46
	You have not used a bobbin that has been designed for this machine.	Incorrect bobbins will not work properly. Only use a bobbin that has been designed for this machine.	page 12
	Bobbin is set incorrectly.	Reset the bobbin thread correctly.	page 14
<b>The thread is tangled on the wrong side of the fabric.</b>	The upper thread was not threaded correctly.	Correct the upper threading.	page 16
<b>The thread tension is incorrect.</b>	You have not threaded the upper thread properly.	Correct the upper threading.	page 16
	You have not wound the bobbin thread properly.	Wind the bobbin thread properly.	page 12
	You have not used the right combination of fabric, thread and needle.	Choose a thread and needle that are appropriate for the type of fabric.	page 19
	You have not attached the presser-foot holder properly.	Attach the presser-foot holder properly.	page 24
	The thread tension is incorrect.	Adjust the tension of the upper thread.	page 28
	You have not used a bobbin that has been designed for this machine.	Incorrect bobbins will not work properly. Only use a bobbin that has been designed for this machine.	page 12
	Bobbin is set incorrectly.	Reset the bobbin thread correctly.	page 14
<b>The upper thread is too tight.</b>	The bobbin thread is incorrectly installed.	Correctly install the bobbin thread.	page 14

Symptom	Possible cause	How to put it right	Reference
<b>The fabric is wrinkled.</b>	You have not threaded the upper thread properly or fitted the bobbin properly.	Thread the upper thread and wind the bobbin thread properly.	page 14, 16
	You have not fitted the spool properly.	Fit the spool properly.	–
	You have not used the right combination of fabric, thread and needle.	Choose a thread and needle that are appropriate for the type of fabric.	page 19
	The needle is bent or blunt.	Replace the needle.	page 20
	If you are sewing thin fabric, the stitch is too thick.	Sew with stabiliser material under the fabric.	page 31
	The thread tension is incorrect.	Adjust the tension of the upper thread.	page 28
<b>Stitches are skipped.</b>	You have not threaded the upper thread properly.	Correct the upper threading.	page 16
	You have not used the right combination of fabric, thread and needle.	Choose a thread and needle that are appropriate for the type of fabric.	page 19
	The needle is bent or blunt.	Replace the needle.	page 20
	You have not inserted the needle properly.	Insert the needle properly.	
	Dust has accumulated under the needle plate or in the shuttle race.	Remove the needle plate cover and clean the plate and the shuttle race.	page 46, 47
<b>There is a high-pitched noise while sewing.</b>	Dust has built up in the feed dogs or in the shuttle race.	Clean the shuttle race.	page 46
	You have not threaded the upper thread properly.	Correct the upper threading.	page 16
	The bobbin case is scratched.	Replace the bobbin case. Contact your retailer or the nearest authorized service center.	–
	You have not used bobbin that has been designed for this machine.	Incorrect bobbins will not work properly. Only use a bobbin that has been designed for this machine.	page 12
	Insufficient oiling.	Make sure to oil the machine once a week if you use it more than an hour a day. If you use it more often, oil every day.	page 45
<b>The stitch is not sewn correctly.</b>	The presser foot that you are using is not correct for the type of stitch.	Attach the presser foot that is correct for the type of stitch that you want to sew.	page 33, 36, 38, 40, 41
	The thread tension is incorrect.	Adjust the tension of the upper thread.	page 28
	The thread is tangled, for example, in the shuttle race.	Remove the tangle thread. If the thread is tangled in the shuttle race, clean the shuttle race.	page 46
<b>The fabric does not feed.</b>	You have not used the right combination of fabric, thread and needle.	Choose a thread and needle that are appropriate for the type of fabric.	page 19
	The thread is tangled, for example, in the shuttle race.	Remove the tangle thread. If the thread is tangled in the shuttle race, clean the shuttle race.	page 46
<b>The sewing light bulb does not come on.</b>	The sewing lamp is damaged.	Change the sewing light bulb.	page 45

# INDEX

- A**  
accessories .....9  
appliqués .....41
- B**  
basic stitching .....33  
blind hem stitching .....33  
bobbin .....14  
bobbin case .....14  
bobbin winder .....12  
button sewing .....38  
buttonhole foot .....36  
buttonhole sewing .....36
- C**  
cleaning .....46
- D**  
darning .....35
- E**  
embroidering .....41  
extra spool pin .....22
- F**  
feed dogs .....8, 47  
flat bed attachment .....8, 31  
foot controller .....27  
free-arm style .....31
- G**  
gathering .....43
- H**  
handwheel .....7
- J**  
joining .....44
- M**  
main parts .....6  
main power switch .....10  
monogramming .....41
- N**  
needle .....19  
needle bar thread guide .....8  
needle clamp screw .....8, 21  
needle plate .....8, 47
- O**  
oiling .....45  
overcasting stitches .....32
- P**  
pattern selection dial .....6, 26  
presser foot .....8, 23  
presser foot holder .....8, 24  
presser foot lever .....7, 16  
pre-tension disk .....12
- R**  
relative chart of sewing fabrics, needles and threads .....19  
repacking .....48  
reverse sewing lever .....28
- S**  
satin stitching .....32  
seam ripper .....37  
sewing machine needles .....19  
shell tuck stitching .....43  
shuttle hook removal .....47  
shuttle race cleaning .....47  
spool pin .....12, 16  
straight stitch .....33  
stretch blind stitch .....33  
stretch fabrics .....31
- T**  
thick fabrics .....30  
thin fabrics .....31  
thread cutter .....28  
thread guide .....16  
thread tension .....28  
trial sewing .....30  
troubleshooting .....50  
twin needle .....21, 22
- U**  
upper tension-control dial .....28, 29, 48  
upper threading .....16
- W**  
winding the bobbin .....12
- Z**  
zigzag stitches .....30, 32, 41  
zipper foot .....40  
zipper insertion .....40

